

Distributed by:

 **dgseals.com**

Electronic Component Specialist

6505 West Park Blvd.
Suite 306 PMB 356
Plano, Texas 75093
USA

www.dgseals.com
sales@dgseals.com
Tel 972 931 8463
Fax 972 931 8668

(Formerly Collmer Components)

MEASURING INSTRUMENTS GENERAL CATALOG

Ver.5

one step beyond tomorrow

MULTI MEASURING INSTRUMENTS CO.,LTD.

CTP-05DC For M-750

UTP-30DC For M-750

Clamp Tester Selection Guide

(1) CLAMP TESTERS FOR LEAKAGE CURRENT

Model	CT (Jaw) Size	Display	AC Current	Resolution (ACA)	DC Current	Resolution (DCA)	Data Hold	Max. Hold	A/D Conversion	CE Conformity	Remarks	Page
100	18mmφ	LCD 1999	200mA/20A	0.1mA	—	—	○	—	Average	—	Mini size,Earth Leakage	2
102	23mmφ	LCD 1999	200mA/100A	0.1mA	—	—	○	—	Average	—	Mini size,Earth Leakage	2
104	33mmφ	LCD 1999	200mA/150A	0.1mA	—	—	○	—	Average	—	Mini size,For small current measurement	2
110	30mmφ	LCD 1999	2mA/20mA/60A	1 μA	—	—	○	—	Average	—	Mini size,High resolution	3
140	40mmφ	LCD 3200	30/300mA 30/300A	0.01mA	—	—	○	—	Average	○	Mini size, Wide ranges	4
310	40mmφ	LCD 3200	30/300mA 30/300A	0.01mA	—	—	○	—	Average	—	Mini size, w/direct touch CT	5
340	40mmφ	LCD 1999	2mA/20mA/60A	1 μA	—	—	○	—	Average	pending	Mini size,High resolution	6
MCL-350	40mmφ	Taut band meter	10mA/50mA/500mA 1/5/50/500A	0.01mA	—	—	○	—	Analog meter	○	ACA, ACV, Ω	7
MCL-400D	40mmφ	LCD 1999	0.2/2/10/200/400A	0.1mA	—	—	○	—	Average	—	ACA, ACV, Ω	7
MCL-400RMS	40mmφ	LCD 4000	40/400mA 4/40/400A	0.01mA	—	—	○	○	True rms	—	High speed sampling 20times/sec	8
MCM-400	40mmφ	LCD 4000	40/400mA 4/40/400A	0.01mA	—	—	○	○	Average	—	Memory function for printer	9
MCL-800D	80mmφ	LCD 1999	200mA/2/20A 200/1000A	0.1mA	—	—	○	—	Average	—	80mmCT, Data output	11
MCL-1100D	108mmφ	LCD 3200	200mA/2/20A 200/1000A	0.1mA	—	—	○	—	True rms	○	Big Jaw	12
MCL-4000F	36mmφ	LCD 1999	200/2000mA 800A	0.1mA	—	—	○	—	Average	—	3CT/4CT Method	13

(2) CLAMP TESTERS FOR LINE CURRENT

Model	CT (Jaw) Size	Display	AC Current	Resolution (ACA)	DC Current	Resolution (DCA)	Data Hold	Max. Hold	A/D Conversion	CE Conformity	Remarks	Page
200	23mmφ	LCD 1999	20A/200A	0.01A	—	—	○	—	Average	—	Mini size, w/direct touch CT	14
210	23mmφ	LCD 1999	20A/200A	0.01A	—	—	○	—	Average	—	Mini size, Economy	14
220	33mmφ	LCD 1999	20A/200A	0.01A	—	—	○	—	Average	○	Mini size, Economy	15
225	40mmφ	LCD 1999	200A/600A	0.1A	—	—	○	—	Average	○	Mini size, Economy	16
3000	40mmφ	Taut band meter	6A/15A/50A 150A/600A	0.1A	—	—	○	—	Analog meter	○	ACA, ACV, Ω	18
2010	40mmφ	LCD 1999	20A/200A/600A	0.01A	—	—	○	—	Average	○	ACA, AC/DC V, Ω ·))} ←	19
2020	40mmφ	LCD 3200	30/300A	0.01A	—	—	○	—	Average	○	ACA, AC/DC V, Ω	17
2100	55mmφ	LCD 1999	20A/200A/2000A	0.01A	—	—	○	—	Average	○	ACA, AC/DC V, Ω ·))} ←	20
M-1800	80mmφ	LCD 1999	20/200A/1800A	0.01A	—	—	○	—	Average	—	80mmCT, Data output	11
MCL-3000D	108mmφ	LCD 3200	30/300/3000A	0.01A	—	—	○	—	True rms	○	Big Jaw	12

(3) CLAMP TESTERS FOR AC/DC CURRENT

Model	CT (Jaw) Size	Display	AC Current	Resolution (ACA)	DC Current	Resolution (DCA)	Data Hold	Max. Hold	A/D Conversion	CE Conformity	Remarks	Page
230	23mmφ	LCD 1999	20A/200A	0.01A	20A/200A	0.01A	○	—	Average	—	Mini size, High accuracy	21
240	30mmφ	LCD 1999	20A/200A	0.01A	20A/200A	0.01A	○	—	Average	○	Mini size, Economy	22
250	40mmφ	LCD 1999	200A/1000A	0.1A	200A/1000A	0.1A	○	—	Average	○	Mini size, Economy	23
260	55mmφ	LCD 4000	400A/1000A	0.1A	400A/1000A	0.1A	○	—	Average	○	AC/DCA, AC/DC V, Ω, Hz ·))} ←	24
270	55mmφ	LCD 4000	400A/1000A	0.1A	400A/1000A	0.1A	○	—	True rms	○	AC/DCA, AC/DC V, Ω, Hz ·))} ←	25
280	40mmφ	LCD 9999	1000A	0.1A	1000A	0.1A	○	○	Average	○	AC/DCA, AC/DC V, Ω	26
290RMS	30mmφ	LCD 4000	40A/400A	0.01A	40A/400A	0.01A	○	—	True rms	○	AC/DCA, AC/DC V, Ω	27
600	20mmφ	LCD 1999	200mA/2000mA/10A	0.1mA	200mA 2000mA/10A	0.1mA	○	○	Average	○	High resolution, CT:Double Shielding	28
700	5mmφ	LCD 9999	100mA/1000mA/10A	0.01mA	100mA 1000mA	0.01mA	○	—	Average	○	Hi precision	29
730	30mmφ	LCD 9999	100mA/1000mA/10A	0.01mA	100mA 1000mA	0.01mA	○	—	Average	○	Hi precision	29

(4) CLAMP TESTERS FOR LINE CURRENT (HIGH-VOLTAGE CIRCUIT)

Model	CT (Jaw) Size	Display	AC Current	Resolution (ACA)	DC Current	Resolution (DCA)	Data Hold	Max. Hold	A/D Conversion	CE Conformity	Remarks	Page
HCL-3000	33mmφ	LCD 1999	200mA/20mA/200A	1mA	—	—	○	—	Average	pending	For high voltage circuit	31
HCL-5000	33mmφ	LCD 1999	20/200/500A	0.01A	—	—	○	—	Average	pending	For high voltage circuit	31
HCL-5000D	40mmφ	LCD 1999	20A/500A	0.01A	—	—	○	—	Average	pending	For high voltage circuit	32
HCL-1000D	35mmφ	LCD 1999	20A/600A	0.01A	—	—	○	—	Average	pending	For high voltage circuit	32
HCL-9000S	35mmφ	LCD 1999	20A/600A	0.01A	—	—	○	—	Average	pending	For high voltage circuit,Optical isolation	33

MINI DIGITAL CLAMP TESTER

AC CURRENT/LEAKAGE

Model 100

AC Current/ Leakage
200mA/20A 18mm ϕ CT



FEATURES

- Model 100 is a clamp-on type ammeter which is least affected by the external magnetic field and which is capable of measuring leakage current.
- Very small electric current flowing into a grounded wire can be measured by high sensitive current transducer.
- The current transducer uses a special alloy that resists rust over long period of use and ensures stable, high-

Model 102

AC Current/ Leakage
200mA/100A 23mm ϕ CT



FEATURES

- Useful 200mA and 100A ranges.
- Data-hold function. Especially useful when working in dark or hard to get areas.
- Ultra compact size.

accuracy measurements with very slight influence from aging.

Model 104

AC Current/ Leakage
200mA/150A 33mm ϕ CT



FEATURES

- 33mm ϕ CT enables the leakage measurement for 60mm square cable.
- Data-hold function. Especially useful when working in dark or hard to get areas.
- Ultra compact size.

SPECIFICATIONS

Model	100		102		104	
Measuring method	Dual integration mode					
Display	3.5 digit LCD					
Range	200mA	20A	200mA	100A	200mA	150A
Resolution	0.1mA	10mA	0.1mA	0.1mA	0.1mA	0.1A
Accuracy (50/60Hz) (23°C \pm 5°C, 80% RH or less)	\pm 1.0% rdg \pm 5 dgt		\pm 2.0% rdg \pm 5 dgt			
Jaw opening capability	18mm ϕ		23mm ϕ		33mm ϕ (No Shielding)	
Overload indication	Blanking of all digits except MSD1					
Maximum indication	1999					
Low battery indication	"B" mark on LCD readout					
Sampling	2 times/s					
Limitation of circuit voltage	Less than AC 600V					
Operating temperature	0°C to 40°C, <80% RH					
Storage temperature	-10°C to 60°C, <70% RH					
Power supply	SR-44(1.55V) \times 2 or LR-44 \times 2					
Power consumption	3mW					
Battery life	SR-44 : 200 hours, LR-44 : 100 hours					
Size	45(W) \times 140(H) \times 20(D)mm		48(W) \times 146(H) \times 20(D)mm(H)		54(W) \times 155(H) \times 20(D)mm	
Weight	Approx. 80g					
Accessories	Soft case \cdots 1		Instruction manual \cdots 1		Batteries(LR-44) \cdots 2	

MINI DIGITAL CLAMP TESTER

AC CURRENT/LEAKAGE

Model **110**

2mA/20mA/60A 30mm ϕ CT



FEATURES

- Model 110 is a clamp-on type ammeter which is least affected by external magnetic fields.
- 30mm ϕ CT enables the leakage current measurement for SV cable (38m²)
- Data hold function. Especially useful when working in dark or hard to get areas.
- Pocket sized and light weight.

SPECIFICATIONS

Measuring method	: Dual integration mode
Display	: 3.5 digit LCD, max. reading of 1999
Range	: 0~2mA/20mA/60A (50/60Hz)
Ranging	: Manual ranging
Accuracy	: 50/60Hz, 23°C \pm 5°C, 80% RH max

Range	Mini.Resolution	Accuracy
2mA	1 μ A	\pm 1.0% rdg \pm 5 dgt
20mA	10 μ A	
60A	100mA	\pm 1.0% rdg \pm 5 dgt (0~50A) \pm 5% rdg \pm 5 dgt (50A~60A)

Jaw opening capability	: 30mm ϕ
Over range indication	: Blanking of all digits except MSD1
Maximum indication	: 1999
Low battery indication	: "B" mark on LCD readout
Data hold indication	: "DH" mark on LCD readout
Sampling	: Approx. 2 times/s.
Limitation of circuit voltage	: Less than AC 600V
Operating temperature	: 0°C to 40°C, <70% RH (Non-condensing)
Storage temperature	: -10°C to 60°C, <70% RH (Non-condensing)
Power supply	: LR-44 or SR-44 \times 2
Power consumption	: Approx. 3mW
Battery Life	: Approx. 100 hours (LR-44) Approx. 200 hours (SR-44)
Size	: 58.5(W) \times 158(H) \times 23(D) mm
Weight	: Approx. 120g
Accessories	: Batteries (LR-44) 2 Instruction manual 1 Carrying case 1

MINI DIGITAL CLAMP TESTER

AC CURRENT

Model **140**

AC Current/Leakage
30/300mA, 30/300A 40mm ϕ CT



FEATURES

- Wide range of current measurements (AC 0.01A~300A).

SPECIFICATIONS

Safety standard	: Meets the requirements for double insulation to IEC 61010-1 (2001), IEC 61010-2-032 (2002) installation Category II 600V phase to earth, Category III 300V phase to earth.
E.M.C. standard	: The instrument meets EN 61326 (2004).
Measuring method	: Dual integration mode
Measuring function	: Leakage current and load current
Display	: 3.5 digital LCD, max. reading of 3200
Range	: 0~30mA/300mA/30A/300A (50/60Hz)
Ranging	: 2 ranges manuals
Accuracy	: 23°C \pm 5 °C, 80% RH max.

Range	Resolution	Accuracy
30/300mA	0.01mA	\pm 1.2% rdg \pm 5 dgt
30/300A	0.01A	0~200A : \pm 1.2% rdg \pm 5 dgt 200~250A : \pm 3.0% rdg \pm 5 dgt 250~300A : \pm 5.0% rdg \pm 5 dgt

Jaw opening capability	: 40mm ϕ
Over range indication	: "OL" mark on LCD readout
Maximum indication	: 3200 counts
Low battery indication	: 2.5V~2.7V; "BAT" mark on LCD readout
Sampling	: Approx. 2 times/s.(Digital display) Approx. 12 times/s. (Bargraph display)
Data hold indication	: "DH" mark on LCD readout
Auto power off	: The meter is set to power off mode approx. 10 minutes after the power switch on.
Withstanding voltage	: AC3700V 1 minute max. (Between the core of CT and outer case)
Operating temperature	: 0 °C to 40 °C, <80% RH (Non-condensing)
Storage temperature	: -10 °C to 60 °C, <70% RH (Non-condensing)
Power supply	: LR-44 or SR-44 \times 2
Power consumption	: Approx. 5mW
Battery life	: Approx. 50 hours (LR44)
Size	: 64(W) \times 162(H) \times 23(D)mm
Weight	: Approx. 125g
Accessories	: Carrying case.....1 Instruction manual.....1 Batteries.....2

MINI DIGITAL CLAMP TESTER

AC CURRENT/LEAKAGE

Model **310**

AC Current/Leakage
30/300mA, 30/300A 40mm ϕ CT & "U" Type CT



FEATURES

- The unique "U" type direct touch CT enables to measure the current of single & three phase circuit just by touching the conductors and it is suitable for the AC current measurement of narrow & congested circuit.

SPECIFICATIONS

Measuring method	: Dual integration mode
Measuring function	: Leakage current and load current
Display	: 3.5 digital LCD, max. reading of 3200
Over range indication	: "OL" mark on LCD readout
Maximum indication	: 3200 counts
Low battery indication	: 2.5V ~ 2.7V; "BAT" mark on LCD readout
Sampling	: Approx. 2 times/s. (Digital display) Approx. 2 times/s. (Bargraph display)
Data hold indication	: "DH" mark on LCD readout
Auto power off	: The meter is set to power off mode approx. 10 minutes after the power switch on.
Operating temperature	: 0°C to 40°C, < 80% RH (Non-condensing)
Storage temperature	: -10°C to 60°C, < 70% RH (Non-condensing)
Power supply	: LR-44 or SR-44 \times 2
Power consumption	: Approx. 5mW
Battery life	: Approx. 50 hours (LR44)
Size	: 64(W) \times 180(H) \times 21(D)
Weight	: Approx. 135g
Accessories	: Carrying case 1 instruction manual 1 Batteries 2

40mm ϕ CT

Range	: 0 ~ 30mA/300mA/30A/300A(50/60Hz)
Ranging	: 2 ranges manuals
Accuracy	: 23°C \pm 5°C, 80% RH max.

Range	Resolution	Accuracy
30/300mA	0.01mA	\pm 1.2% rdg \pm 5 dgt
30/300A	0.01A	0~200A : \pm 1.2% rdg \pm 5 dgt
		200~250A : \pm 3.0% rdg \pm 5 dgt
		250~300A : \pm 5.0% rdg \pm 5 dgt

Jaw opening capability : 40mm ϕ

"U" Type CT

Range	: 300A (Resolution 0.1A)
Accuracy	: 23°C \pm 5°C, 80% RH max.

Single Phase IV Conductor	\pm 5%
Parallel VVF Conductor	\pm 5%
Three Phase VVR Conductor	Estimated Value

Max Measurement Conductor : 20mm ϕ

MINI DIGITAL CLAMP TESTER

AC CURRENT/LEAKAGE

Model **340**

2mA/20mA/60A 40mm ϕ CT



FEATURES

- Model 340 is a clamp-on type ammeter which is least affected by external magnetic fields.
- Enabled high resolution measurement with 40 mm ϕ CT by our new CT technology.

SPECIFICATIONS

Safety standard	: Meets the requirements for double insulation to IEC 61010-1 (2001), IEC 61010-2-032 (2002) installation Category II 600V phase to earth, Category III 300V phase to earth.
Measuring method	: Dual integration mode
Display	: 3.5 digit LCD, max. reading of 1999
Range	: 0~2mA/20mA/60A (50Hz)
Ranging	: Manual ranging
Accuracy	: 50/60Hz, 23°C \pm 5°C 80% RH max.

Range	Mini.Resolution	Accuracy
2mA	1 μ A	\pm 1.0% rdg \pm 5 dgt
20mA	10 μ A	
60A	100mA	\pm 1.0% rdg \pm 5 dgt(0~50A) \pm 5% rdg \pm 5 dgt(50A~60A)

Jaw opening capability	: 40mm ϕ
Over range indication	: Blanking of all digits except MSD1
Maximum indication	: 1999
Low battery indication	: "B" mark on LCD readout
Data hold indication	: "DH" mark on LCD readout
Sampling	: Approx. 2 times/s.
Operating temperature	: 0°C to 40°C, <70% RH (Non-condensing)
Storage temperature	: -10°C to 60°C, <70% RH (Non-condensing)
Power supply	: LR-44 or SR-44 \times 2
Power consumption	: Approx. 3.5mW
Battery life	: Approx. 80 hours (LR-44) Approx. 160 hours (SR-44)
Size	: 68.5(W) \times 175(H) \times 23(D)mm
Weight	: Approx. 145g
Accessories	: Batteries (LR-44) 2 Instruction manual 1 Carrying case 1

CLAMP TESTER

AC CURRENT/LEAKAGE

Model MCL-350

10mA ~ 500A 7ranges

40mm ϕ CT



Model MCL-400D

0.2A ~ 400A 5ranges

40mm ϕ CT



FEATURES

- High accuracy analog display with strong taut band meter.
- 3 years long battery life.
- Meter lock function and data output for recorder.
- Filter circuit for high frequency noise rejection.

SPECIFICATIONS

Current	AC 0~10mA/50mA/500mA/1A 5A/50A/500A
Accuracy	$\pm 3\%$ of F.S. (50/60Hz)
Voltage	AC 0~500V
Accuracy	$\pm 3\%$ of F.S. (50/60Hz)
Resistance	0~1K Ω (25 Ω center)
Accuracy	$\pm 3\%$ of scale length
Data output	DC 100mV (Full scale)
Affection of magnetic field	3mA or less (At 100A near by conductor)
Safety standard	Meets the requirements for double insulation to IEC 61010-1 (2001), IEC 61010-2-032 (2002) installation Category II 600 volts phase to earth, Category III 300 volts phase to earth.
E.M.C. standard	The instrument meets EN 61326 (2004).
Operating temperature	0 $^{\circ}$ C to 40 $^{\circ}$ C, <80% RH
Storage temperature	-10 $^{\circ}$ C to 60 $^{\circ}$ C, <70% RH
Power supply	1.5V("AAA"size,UM-4) \times 2
Size	65(W) \times 210(H) \times 34(D)mm
Weight	Approx. 400g(Included batteries)
Accessories	Carrying case 1 Instruction manual 1 Batteries(UM-4) 2 Spare fuse 1 Test lead 1set

FEATURES

- Digital clamp-on tester with wide range of current measurement from 0.1A to 400A.

SPECIFICATIONS

Measuring method	Dual integration mode		
Display	3.5digit LCD		
Accuracy	(23 $^{\circ}$ C \pm 5 $^{\circ}$ C, 80% RH or less)		
AC Current (50/60Hz)	Range	Resolution	Accuracy $\pm 1.0\%$ rdg ± 5 dgt
	0.2A	0.1mA	
	2A	1mA	
	20A	0.01A	
	200A	0.1A	
AC Voltage	400A	1A	$\pm 1.0\%$ rdg $\pm 3.0\%$ of F.S.
	600V	1V	
Resistance	2K Ω	1 Ω	$\pm 1.0\%$ rdg $\pm 3.0\%$ of F.S.
	2K Ω	1K Ω	
Jaw opening capability	40mm ϕ		
Overload indication	Blanking of all digits except MSD1		
Maximum indication	1999		
Low battery indication	"B" mark on LCD readout		
Sampling	2 times/s		
Limitation of circuit voltage	Less than AC 600V		
Data hold indication	"D · H" mark on LCD readout		
Affection of magnetic field	3mA or less (at 100A near by conductor)		
Power supply	1.5V("AAA"size,UM-4) \times 2		
Size	69(W) \times 197(H) \times 32(D)mm		
Weight	Approx. 370g (Included batteries)		
Accessories	Carrying case 1 Instruction manual 1 Batteries(UM-4) 2 Test lead 1set		

DIGITAL CLAMP TESTER

AC CURRENT/LEAKAGE

Model MCL-400RMS

40mA ~ 400A 5ranges

True RMS 40mm ϕ CT



FEATURES

- 20 times/sec. high speed sampling with True RMS reading.
- High speed response for max hold enables the measurement for the instantaneous tripping leakage current of the circuit breaker.

SPECIFICATIONS

Measuring method		Dual integration mode	
Display		3 $\frac{3}{4}$ digit LCD	
Accuracy (23°C \pm 5°C, 80% RH or less)			
	Range	Resolution	Accuracy
	40mA	0.01mA	$\pm 1.0\%$ rdg ± 5 dgt (50/60Hz)
	400mA	0.1mA	
	4A	1mA	
	40A	0.01A	
	400A	0.1A	$\pm 1.0\%$ rdg $\pm 2\%$ of F.S.
A/D conversion		True rms reading	
Jaw opening capability		40mm ϕ	
Overload indication		"OL" mark on LCD readout	
Maximum indication		4000	
Low battery indication		"B" mark on LCD readout	
Data hold indication		"DATA" mark on LCD readout	
Max.hold indication		"MAX" mark on LCD readout	
Affection of magnetic field		3mA or less (At 100A near by conductor)	
Sampling		20 times/s	
Limitation of circuit voltage		Less than AC 600V	
Operating temperature		0°C to 40°C, <80% RH	
Storage temperature		-10°C to 60°C, <70% RH	
Power supply		6LR61 or AC adaptor	
Withstanding voltage		AC2000V, 1minute	
Size		69(W) \times 207(H) \times 33(D)mm	
Weight		Approx. 450g	
Accessories		Carrying case 1 Instruction manual 1	
Optional accessory		AC adaptor (DC9V)	

DIGITAL CLAMP MONITOR

AC CURRENT/LEAKAGE

Model **MCM-400**

Max Hold Function
Memory Function 40mm ϕ CT



(DPU-201G Printer)

(MCM-400)

[Printing Format]

```

***** MONITOR LIST *****
START DAY 08-27 13:03
STOP DAY 08-27 17:02
LEVEL 1.000 A
RATIO 0001
COUNT 018
DATA 01 START 08-27 17:02
      STOP 08-27 17:02
      AVG 1.875 A
      MAX 3.009 A
DATA 02 START 08-27 16:55
      STOP 08-27 17:01
      AVG 1.963 A
      MAX 2.000 A
DATA 03 START 08-27 16:33
      STOP 08-27 16:50
      AVG 2.453 A
      MAX 3.302 A
DATA 04 START 08-27 16:31
      STOP 08-27 16:33
      AVG 2.246 A
      MAX 2.299 A
DATA 05 START 08-27 16:10
      STOP 08-27 16:16
      AVG 2.250 A
      MAX 2.299 A
DATA 06 START 08-27 16:08
      STOP 08-27 16:08
      AVG 1.055 A
      MAX 1.297 A
DATA 07 START 08-27 15:53
      STOP 08-27 15:56
      AVG 1.278 A
      MAX 1.299 A
DATA 08 START 08-27 15:49
      STOP 08-27 15:49
      AVG 1.241 A
      MAX 1.937 A
DATA 09 START 08-27 15:45
      STOP 08-27 15:47
      AVG 3.269 A
      MAX 3.424 A
DATA 10 START 08-27 15:29
      STOP 08-27 15:42
      AVG 1.237 A
      MAX 2.219 A
DATA 11 START 08-27 15:26
      STOP 08-27 15:26
      AVG 1.176 A
      MAX 1.454 A
DATA 12 START 08-27 15:10
      STOP 08-27 15:20
      AVG 2.477 A
      MAX 2.524 A
DATA 13 START 08-27 14:58
      STOP 08-27 14:58
      AVG 1.211 A
      MAX 1.514 A
***** E N D *****
CURRENT MONITOR
    
```

FEATURES

- Monitoring for maximum current.
- Monitoring for leakage current.
- AC current/ leakage clamp-on tester.

SUPER FUNCTIONS

- 13 data can be stored and displayed.
- The memory is backed up 5 days.
- The measuring range is extendable by using LAD-800 clamp-on adaptor.
- The number of acquisition is displayed up to 255.

This intelligent clamp-on monitor was designed to measure and monitor the maximum current of the circuit.

Also, it is useful to measure and monitor the leakage current of the circuit.

When the measured current exceeded the setting value, the data of "Memory start Time", "Memory stop Time", "Acquired Average Current" and "Acquired Maximum Current" are stored into the memory and displayed.

The memorized data can be printed out in connection with optionally available DPU-201G printer.

[Example of Display]



Leakage current



Time setting



Memory start time



Memory stop time



Average value



Max value

DIGITAL CLAMP MONITOR / Model MCM-400

AC CURRENT/LEAKAGE

SPECIFICATIONS

Memory	13 data(Refer to printing format)	
Memory back up	Approx. 5 days	
Interface for printer	Centronics system	
Clock	Quartz	
Accuracy of clock	±60 sec./month (23°C ±5°C)	
Measuring method	Dual integration mode	
Display	3 ¾ digit LCD	
Accuracy	(23°C ±5°C, 80% RH or less)	
Range	Resolution	Accuracy
40mA	0.01mA	±1.0% rdg ±5 dgt (50/60Hz)
400mA	0.1mA	
4A	1mA	
40A	0.01A	
400A	0.1A	±1.0% rdg ±2% of F.S.
A/D conversion	Average reading	
Jaw opening capability	40mmφ	
Maximum indication	4000	
Overload indication	"OL" mark on LCD readout	

Low battery indication	"B" mark on LCD readout
Data hold indication	"DATA" mark on LCD readout
Max.hold indication	"MAX" mark on LCD readout
Affection of magnetic field	3mA or less (At 100A near by conductor)
Sampling	20 times/s
Limitation of circuit voltage	Less than AC 600V
Operating temperature	0°C to 40°C, <70% RH
Storage temperature	-10°C to 60°C, <70% RH
Power supply	6LR61 or AC adaptor
Withstanding voltage	AC2200V, 1minute
Size	69(W)×207(H)×33(D)mm
Weight	Approx.430g
Accessories	Carrying case..... 1 Instruction manual..... 1
Optional accessory	AC adaptor (DC 9V)

THERMAL PRINTER

APPLICABLE for MCM-400

Model DPU-201G

FEATURES

- Rechargeable Ni-Cad batteries are used.
- Centronics system is used for data input.
- Convenient compact size.



SPECIFICATIONS

Printing column	27
Printing method	Thermal dot matrix
Data input	Centronics system
Charactor configuration	7×5 dot matrix
Printing width	46mm
Ptinting speed	0.8 line/ sec.
Printing paper	58mm (W)
Charactor size	2.4mm(H)×1.3mm(W)
Number of dot	8(H)×166(W)/ line
Power supply	4.8V (Ni-Cad batteries, 500m AH)
Size	135(W)×100(D)×35(H)mm
Weight	Approx. 400g
Accessories	Communication cable..... 1 AC adaptor 1 Instruction manual..... 1

DIGITAL CLAMP TESTER

AC CURRENT/LEAKAGE, AC CURRENT

Model MCL-800D

200mA ~ 1000A 5ranges
80mm ϕ CT



FEATURES

- 80mm ϕ CT window.
- DC mV analog data output for recorder.
- The least affection from external magnetic field.
- Continuous long time measurement and useful data hold function.

SPECIFICATIONS

Measuring method	Dual integration mode	
Display	3.5 digit LCD	
Accuracy	(23°C \pm 5°C, 80% RH or less)	
Range	Resolution	Accuracy
200mA	0.1mA	\pm 2.0% rdg \pm 5dgt (50/60Hz)
2A	1mA	
20A	10mA	
200A	0.1A	
1000A	1A	
Jaw opening capability	80mm ϕ	
Overload indication	Blanking of all digits except MSD1	
Maximum indication	1999	
Low battery indication	"B" mark on LCD readout	
Sampling	2 times/s	
Data hold indication	"D · H" mark on LCD readout	
Data output	DC 100mV (Full count)	
Withstanding voltage	AC2000V	
Limitation of circuit voltage	Less than AC 600V	
Operating temperature	0°C to 40°C, <80% RH	
Storage temperature	-10°C to 60°C, <70% RH	
Power supply	UM-4(1.5V) \times 2	
Power consumption	3mW	
Battery life	350hours (By alkaline batteries)	
Size	138(W) \times 225(H) \times 37(D)mm	
Weight	Approx. 500g	
Accessories	Carrying case..... 1 Instruction manual 1 Batteries(UM-4) 2	

Model M-1800

20A/2000A/1800A/ 5ranges
80mm ϕ CT



FEATURES

- 80mm ϕ CT window and continuous long time measurement.
- DC mV analog data output for recorder.

SPECIFICATIONS

Measuring method	Dual integration mode	
Display	3.5 digit LCD	
Accuracy	(23°C \pm 5°C, 80% RH or less)	
Range	Resolution	Accuracy
20A	10mA	\pm 3.0% rdg \pm 3dgt (50/60Hz)
200A	0.1A	
1800A	1A	
Jaw opening capability	80mm ϕ	
Overload indication	Blanking of all digits except MSD1	
Maximum indication	1999	
Low battery indication	"B" mark on LCD readout	
Sampling	2 times/s	
Data hold indication	"D · H" mark on LCD readout	
Data output	DC 100mV (Full count)	
Withstanding voltage	AC2000V	
Limitation of circuit voltage	Less than AC 600V	
Operating temperature	0°C to 40°C, <80% RH	
Storage temperature	-10°C to 60°C, <70% RH	
Power supply	UM-4(1.5V) \times 2	
Power consumption	3mW	
Battery life	350hours (By alkaline batteries)	
Size	138(W) \times 225(H) \times 37(D)mm	
Weight	Approx. 500g	
Accessories	Carrying case..... 1 Instruction manual 1 Batteries(UM-4) 2	

BIG WINDOW DIGITAL CLAMP TESTER

AC CURRENT/LEAKAGE, AC CURRENT

Model MCL-1100D

1mA ~ 3000A 5ranges



FEATURES

- 108 × 128mm big CT window.
- DC mV analog data output for recorder.
- Wide ranges for 0.1mA — 3000A
Safety Standavd : CAT. II 600V

SPECIFICATIONS

Measuring method	True rms reading	
Display	3.5 digit LCD	
Accuracy	(23°C ± 5°C, 80% RH or less)	
Range	Resolution	Accuracy
300mA	0.1mA	± 1.5% rdg ± 8dgt (50/60Hz)
3A	0.001A	
30A	0.01A	
300A	0.1A	
3000A	1A	
Jaw opening capability	108mmφ	
Overload indication	"OL" mark	
Maximum indication	3200	
Low battery indication	"B" mark on LCD readout	
Sampling	2 times/s	
Data hold indication	"D · H" mark on LCD readout	
Data output	DC 300mV (Full count)	
Withstanding voltage	AC3700V	
Limitation of circuit voltage	Less than AC 500V	
Operating temperature	0°C to 40°C, <80% RH	
Storage temperature	-10°C to 60°C, <70% RH	
Power supply	UM-4(1.5V) × 2	
Power consumption	6mW	
Battery life	200hours (By alkaline batteries)	
Size	194(W) × 341.5(H) × 52(D)mm	
Weight	Approx. 1900g	
Accessories	Carrying case 1 Instruction manual 1 Batteries(UM-4) 2	

Model MCL-3000D

30A/300A/3000A 3ranges



FEATURES

- 108 × 128mm big CT window.
- DC mV analog data output for recorder.
- Wide ranges for 0.1mA — 3000A
Safety Standavd : CAT. III 600V

SPECIFICATIONS

Measuring method	True rms reading	
Display	3.5 digit LCD	
Accuracy	(23°C ± 5°C, 80% RH or less)	
Range	Resolution	Accuracy
30A	0.01A	± 1.5% rdg ± 8dgt (50/60Hz)
300A	0.1A	
3000A	1A	
Jaw opening capability	108mmφ	
Overload indication	On the LCD readout	
Maximum indication	3200	
Low battery indication	"B" mark on LCD readout	
Sampling	2 times/s	
Data hold indication	"D · H" mark on LCD readout	
Data output	DC 300mV (Full count)	
Withstanding voltage	AC5550V	
Limitation of circuit voltage	Less than AC 500V	
Operating temperature	0°C to 40°C, <80% RH	
Storage temperature	-10°C to 60°C, <70% RH	
Power supply	UM-4(1.5V) × 2	
Power consumption	6mW	
Battery life	200hours (By alkaline batteries)	
Size	194(W) × 341.5(H) × 52(D)mm	
Weight	Approx. 1850g	
Accessories	Carrying case 1 Instruction manual 1 Batteries(UM-4) 2	

3CT METHOD LEAKAGE CURRENT METER

Model **MCL-4000F**

**New Method-Can Measure Leakage Current
by clamping 3 or 4 CTs respectively to the conductors**

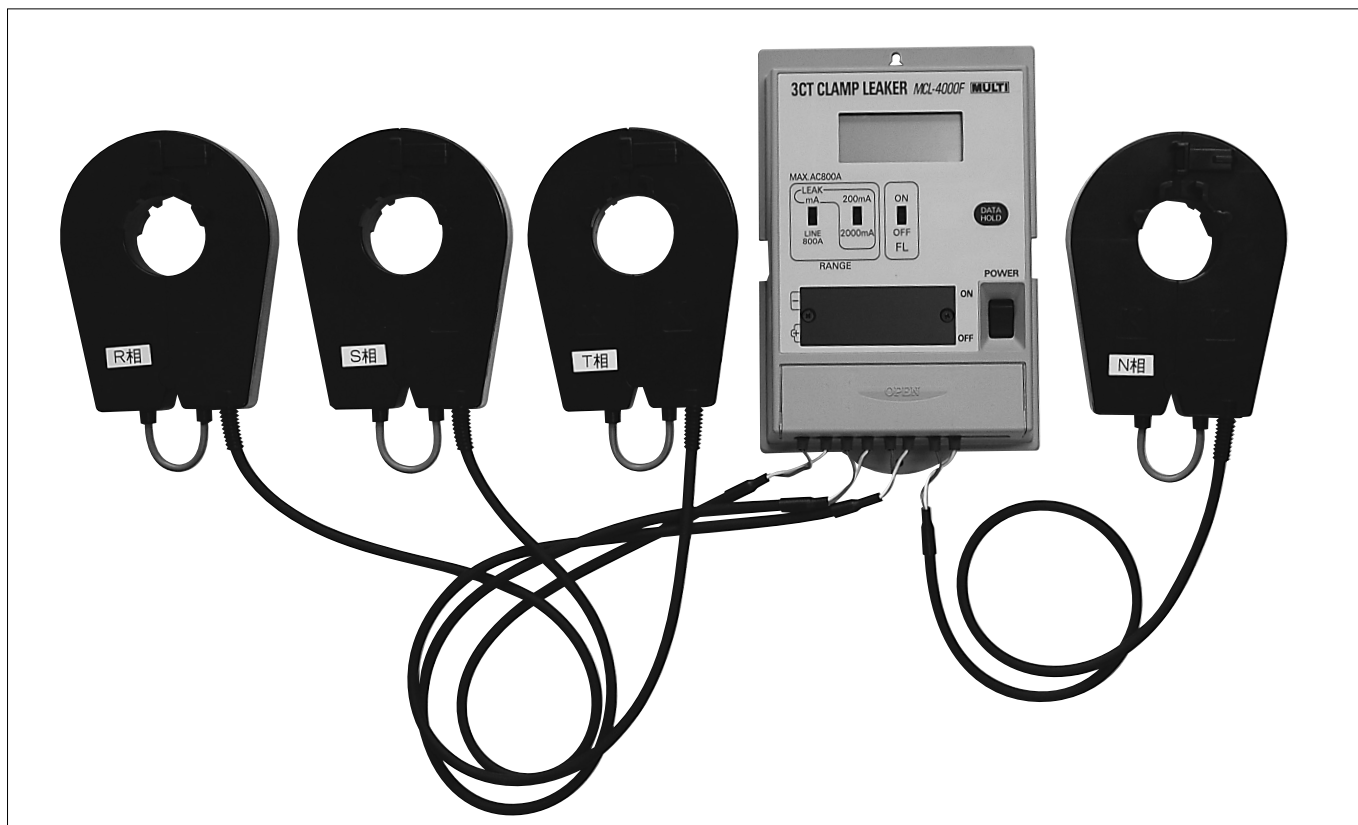

Most suitable to measure the leakage current in the fields where one CT cannot be clamped to the wires en bloc and also, this model can measure each line current up to AC 800A.

SPECIFICATIONS

(Display Part)

Measuring Range : AC 0~2000mA/0~800A
Accuracy : $\pm 1\% \text{rdg} \pm 5 \text{dgt}$
Measuring Method : Dual integration mode
Sampling Rate : 2 times/sec.
Filter Function : Hi-Frequency Cut
(LPF=130Hz)
DC mV Output : 100mV F.S.
Power Supply : UM-4(1.5V)×2
Size & Weight : 130×200×38mm, 500g

(CT Part)

Diameter : $\phi 36 \text{mm}$
Applicable Current : less than AC 800A
Circuit Voltage : less than 600V
Remanence : less than 10mA at 100A
Size & Weight : 100×130×25mm, 420g
Cable Length : 3m

Accessories

3 CTs, Carrying Case, Batteries and Instruction Manual
Option : CT for 3P/4W.(Model No. MCL-4000F-NCT)

MINI DIGITAL CLAMP TESTER

AC CURRENT

Model 200

AC Current
20A/200mA 33mm ϕ CT & "U" Type CT



FEATURES

- with "U" Type Direct Touch CT enables AC current measurement of Single & Three Phase Circuit just by touching CT to conductor.

SPECIFICATIONS

Measuring method : Dual integration mode
 Display : 3.5 digit LCD max. reading of 1999
 Over range indication : Blanking of all digits except MSD1
 Maximum indication : 1999
 Low battery indication : "B" mark on LCD
 Data hold indication : "DH" mark on LCD
 Sampling time : 2 times/sec
 Operating temperature : 0°C to +40°C, < 80% RH
 Storage temperature : -10°C to +60°C, < 70% RH
 Power supply : SR-44 (1.55V) \times 2 or LR-44 \times 2
 Power consumption : 2.5 mW
 Battery life : SR-44 (200 hours), LR-44 (100 hours)
 Size : 54(W) \times 170(H) \times 21(D)mm
 Weight : Approx. 100g
 Accessories : Soft case $\cdots\cdots$ 1
 instruction manual $\cdots\cdots$ 1
 Batteries, LR-44 (1.55V) $\cdots\cdots$ 2

33mm ϕ CT

Range : 0 ~ 20/200A
 Accuracy : 23°C \pm 5°C 80% RH or less

Range	Resolution	Accuracy
20A	10mA	$\pm 1.2\%$ rdg ± 5 dgt (50/60Hz)
200A	100mA	

"U" Type CT

Range : 300A (Resolution 0.1A)
 Accuracy : 23°C \pm 5°C, 80% RH max.

Single Phase IV Conductor	$\pm 5\%$
Parallel VVF Conductor	$\pm 5\%$
Three Phase VVR Conductor	Estimated Value

Max Measurement Conductor : 20mm ϕ

Model 210

AC Current
20A/200mA 33mm ϕ CT



FEATURES

- Ultra compact size with 23mm ϕ CT.
- Most suitable for the use of the narrow & congested circuit.

SPECIFICATIONS

Measuring method : Dual integration mode
 Display : 3.5 digit LCD max. reading of 1999
 Range : 0 ~ 20/200A
 Accuracy : 23°C \pm 5°C 80% RH or less

Range	Resolution	Accuracy
20A	10mA	$\pm 1.2\%$ rdg ± 5 dgt (50/60Hz)
200A	100mA	

Jaw opening capability : 23mm ϕ
 Over range indication : Blanking of all digits except MSD1
 Maximum indication : 1999
 Low battery indication : "B" mark on LCD
 Data hold indication : "DH" mark on LCD
 Sampling time : 2 times/sec
 Operating temperature : 0°C to +40°C < 80% RH
 Storage temperature : -10°C to +60°C < 70% RH
 Power supply : SR-44 (1.55V) \times 2 or LR-44 \times 2
 Power consumption : 2.5 mW
 Battery life : SR-44 (200 hours), LR-44 (100 hours)
 Size : 48(W) \times 146(H) \times 20(D)mm
 Weight : Approx. 80g
 Accessories : Soft case $\cdots\cdots$ 1
 instruction manual $\cdots\cdots$ 1
 Batteries, LR-44 (1.55V) $\cdots\cdots$ 2

MINI DIGITAL CLAMP TESTER

AC CURRENT

Model **220**

AC Current
20A/200A 33mm ϕ CT

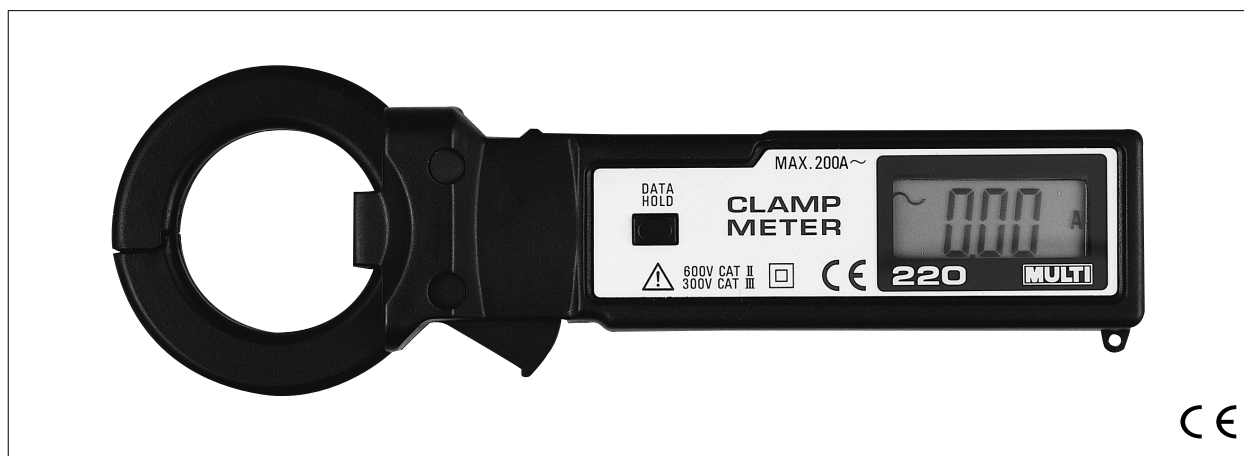

FEATURES

- 33mm ϕ CT window, and ultra compact size
- Data-hold function. Especially useful when working in dark or hard to get areas.
- Conform to IEC safety requirements.

SPECIFICATIONS

Safety standard	: Meets the requirements for double insulation to IEC 61010-1 (2001), IEC 61010-2-032 (2002) installation Category II 600V phase to earth, Category III 300V phase to earth.
E.M.C. standard	: The instrument meets EN 61326 (2004).
Measuring method	: Dual integration mode
Display	: 3.5 digit LCD max. reading of 1999
Range	: 0~20/200A
Accuracy	: 23°C \pm 5 °C 80%RH or less

Range	Resolution	Accuracy
20A	10mA	\pm 1.2% rdg \pm 5dgt (50/60Hz)
200A	100mA	

Jaw opening capability	: 33mm ϕ
Over range indication	: Blanking of all digits except MSD1
Maximum indication	: 1999
Low battery indication	: "B" mark on LCD
Data hold indication	: "DH" mark on LCD
Sampling time	: 2 times/sec
Withstanding voltage	: AC 3700V 1 minute max. (Between the core of CT and outer case)
Operating temperature	: 0°C to +40 °C <80%RH
Storage temperature	: -10°C to +60°C <70%RH
Power supply	: SR-44(1.55V) \times 2 or LR-44 \times 2
Power consumption	: 3mW
Battery life	: SR-44(200 hours), LR-44(100 hours)
Size	: 54(W) \times 167(H) \times 23(D)mm
Weight	: Approx. 100g
Accessories	: Soft case.....1 Instruction manual.....1 Batteries, LR-44(1.55V).....2

MINI DIGITAL CLAMP TESTER

AC CURRENT

Model **225**

AC Current
200A/600A 40mm ϕ CT



FEATURES

- 40mm ϕ CT window, and ultra compact size.
- Data hold function. Especially useful when working in dark or hard to get areas.
- Conform to IEC safety requirements.

SPECIFICATIONS

Safety standard	: Meets the requirements for double insulation to IEC 61010-1 (2001), IEC 61010-2-032 (2002) installation Category II 600V phase to earth, Category III 300V phase to earth.
E.M.C. standard	: The instrument meets EN 61326 (2004).
Measuring method	: Dual integration mode
Display	: 3.5 digit LCD, max. reading of 1999
Range	: 0~200A/600A
Accuracy	: 23°C \pm 5°C, 80% RH or less (50/60Hz)

Range	Resolution	Accuracy
200A	100mA	\pm 1.5% rdg \pm 5 dgt
600A	1A	\pm 1.0% rdg \pm 8 dgt

Jaw opening capability	: 40mm ϕ
Over range indication	: Blanking of all digits except MSD1
Maximum indication	: 1999
Low battery indication	: "B" mark on LCD readout
Data hold indication	: "DH" mark on LCD readout
Sampling	: 2 times/sec.
Withstanding voltage	: AC 3700V 1minute max. (Between the core of CT and outer case)
Operating temperature	: 0°C to 40°C, 80% RH max. (Non-condensing)
Storage temperature	: -10°C to 60°C, 70% RH max. (Non-condensing)
Power supply	: 1.55V (SR-44 LR-44) \times 2
Power consumption	: 5mW
Battery life	: SR-44 (200 hours), LR-44 (100 hours)
Size	: 64 (W) \times 175(H) \times 23(D)mm
Weight	: Approx. 115g
Accessories	: Soft case.....1 Instruction manual.....1 Batteries LR-44 (1.55V).....2

MINI DIGITAL CLAMP TESTER

AC CURRENT AC/DC VOLTAGE RESISTANCE

Model **2020**

meets safety Standard CAT.II 600V and CAT.III 300V

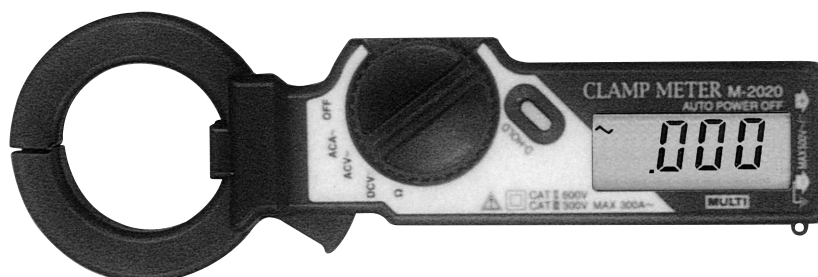

FEATURES

- 40mm ϕ CT window and ultra compact size
- Low cost and multi-function clamp tester.
- Data-hold function and auto power off.
- Conform to IEC safety requirements.

SPECIFICATIONS

Safety standard	: Meets the requirements for double insulation to IEC 61010-1 (2001), IEC 61010-2-032 (2002) installation Category II 600V phase to earth, Category III 300V phase to earth.
E.M.C. standard	: The instrument meets EN 61326 (2004).
Measuring method	: Dual integration mode
Display	: 3.5 digit LCD max. reading of 3200
Measuring range	: AC Current 30A/300A (2 range auto) AC Voltage 3V~500V (4 ranges auto, 50/60Hz) DC Voltage 300mV~500V(5 range auto) Resistance 300 Ω /3000 Ω (2 range auto)
Accuracy	: 23°C \pm 5°C 80%RH or less
AC Current (ACA)	: 0~300A 2%rdg \pm 8dgt
AC Voltage(ACV)	: 0~500V 2.3%rdg \pm 6dgt
DC Voltage (DCV)	: 0~500V 1.3%rdg \pm 3dgt
Resistance (Ω)	: 0~3000 Ω 2%rdg \pm 5dgt
Jaw opening capability	: 40mm ϕ
Over range indication	: "OL" mark on LCD.
Auto power off	: Automatically power off mode approx.10 minutes after the power switch on.
Low battery indication	: "B" mark on LCD
Data hold indication	: "DH" mark on LCD
Sampling time	: 2 times/sec
Circuit voltage	: less than AC 500V.
Withstanding voltage	: AC 3700V 1 minute max. (Between the core of CT and outer case)
Operating temperature	: 0°C to ~ 40°C <80%RH (without condensing)
Storage temperature	: -10°C to ~ 60°C <70%RH (without condensing)
Power supply	: SR-44(1.55V) \times 2 or LR-44 \times 2
Power consumption	: 5mW
Battery life	: SR-44(200 hours), LR-44(100 hours)
Size	: 64(W) \times 193(H) \times 24(D)mm
Weight	: Approx. 100g
Accessories	: Soft case.....1 Instruction manual.....1 Batteries, LR-44(1.55V)....2 Test Lead.....1

ANALOG CLAMP TESTER

AC CURRENT

Model **3000**

6A ~ 600A 5 ranges

40mm ϕ CT



FEATURES

- High accuracy analog display with taut band meter.
- Meter hold function.
- AC/DC voltage and resistance measurements.

SPECIFICATIONS

Safety standard	: Meets the requirements for double insulation to IEC 61010-1 (2001), IEC 61010-2-032 (2002) installation Category III 600V phase to earth.
E.M.C. standard	: The instrument meets EN 61326 (2004).
Withstanding voltage	: AC 5500V, 1 minute (between outer case and core of CT)
Jaw opening capability	: 40mm ϕ
Current	: AC 6A/15A/50A/150A/600A Accuracy; $\pm 3\%$ of F.S. (50/60Hz)
Voltage	: AC 0~300V/600V DC 0~60V Accuracy; $\pm 3\%$ of F.S. (50/60Hz)
Resistance	: 0~1k Ω /100k Ω (50 Ω /5k Ω center) Accuracy; $\pm 3\%$ of scale length
Temperature	: -50 $^{\circ}\text{C}$ to 200 $^{\circ}\text{C}$ (Thermister sensor)
Operating temperature	: 0 $^{\circ}\text{C}$ to 40 $^{\circ}\text{C}$, <80%RH
Storage temperature	: -10 $^{\circ}\text{C}$ to 60 $^{\circ}\text{C}$, <70%RH
Power supply	: 1.5V ("AAA" size, R03) $\times 2$
Size	: 69(W) \times 210(H) \times 34(D)mm
Weight	: Approx. 400g (Including batteries)
Accessories	: Carrying case..... 1 Instruction manual..... 1 Batteries..... 2 Test lead..... 1 set
Optional Accessories	: MT-3000 Thermister sensor probe

DIGITAL CLAMP TESTER

AC CURRENT

Model **2010**

20A / 200A / 600A

40mm ϕ CT



FEATURES

- Multi function clamp-on tester
- Additional AC/DC voltage, resistance, diode test and continuity check.
- Data hold and auto power off function.

SPECIFICATIONS

- Safety standard : Meets the requirements for double insulation to IEC 61010-1 (2001), IEC 61010-2-032 (2002) installation Category III 600V phase to earth.
- E.M.C. standard : The instrument meets EN 61326 (2004).
- Withstanding voltage : AC 5500V, 1 minute (between outer case and core of CT)
- Measuring method : Dual integration mode
- Jaw opening capability : 40mm ϕ
- Display : 3 1/2 digit LCD max. reading of 2000 and annunciators
- Over range indication : Blanking of all digits except MSD1 (Except AC/DC 600V and AC 600A range)
- Low battery indication : " [B] " mark on LCD readout
- Sampling : 2 times/s
- Data hold indication : "DH" mark on LCD readout
- Auto power off : The meter is set to power off mode approx. 10 minutes after the power switch on.

Operating temperature	: 0°C to 40°C, <80%RH
Storage temperature	: -10°C to 60°C, <70%RH
Power supply	: "AAA" size, R03(1.5V)×2
Power consumption and battery life	: Approx. 3.5mW, 500hours continuous.
Size	: 70(W)×223(H)×34(D)mm
Weight	: Approx. 425g
Accessories	: Carrying case.....1 Test lead.....1 set Instruction manual.....1 Batteries.....2

Measuring ranges (23°C±5°C, < 80%RH) :

Range	Accuracy	Max. input
~A (50/60Hz) Manual range	20A	AC 600A
	200A	
	600A	
~V (50/60Hz) ≡V Auto range	2V	AC/DC 600V rms
	20V	
	200V	
	600V	
Ω (OHM) Auto range	200 Ω	Input protection 250V rms
	2K Ω	
	20K Ω	
	200K Ω	
	2000K Ω	
·))) Continuity check	2K Ω	250V rms
	Diode Test	250V rms

DIGITAL CLAMP TESTER

AC CURRENT

Model **2100**

20A / 200A / 2000A

55mm ϕ CT



FEATURES

- Wide range of current measurements with tear drop style CT up to 2000A range.
- Additional AC/DC voltage, resistance, diode test and continuity check.
- Data hold and auto power off function.

SPECIFICATIONS

Safety standard	: Meets the requirements for double insulation to IEC 61010-1 (2001), IEC 61010-2-032 (2002) installation Category III 600V phase to earth.
E.M.C. standard	: The instrument meets EN 61326 (2004).
Measuring method	: Dual integration mode
Jaw opening capability	: 55mm ϕ
Display	: 3 1/2 digit LCD max. reading of 1999 and annunciators
Over range indication	: Blanking of all digits except MSD1
Low battery indication	: " [B] " mark on LCD readout
Sampling	: 2 times/s
Data hold indication	: "DH" mark on LCD readout
Auto power off	: The meter is set to power off mode approx. 10 minutes after the power switch on.
Operating temperature	: 0°C to 40°C, <80%RH
Storage temperature	: -10°C to 60°C, <70%RH

Power supply	: "AAA" size, R03(1.5V)×2
Power consumption and battery life	: Approx. 3.5mW, 500 hours continuous.
Size	: 85(W)×240(H)×34(D)mm
Weight	: Approx. 350g
Accessories	: Carrying case1 Test lead1 set Instruction manual1 Batteries2

Measuring ranges (23°C±5°C, < 80%RH) :

Range	Accuracy	Max. input
~A (50/60Hz) Manual range	20A	AC 2000A (30 seconds)
	200A	
	2000A	
~V (50/60Hz) =V Auto range	2V	AC/DC 600V rms
	20V	
	200V	
	600V	
Ω (OHM) Auto range	200 Ω	Input protection 250V rms (30 seconds)
	2K Ω	
	20K Ω	
	200K Ω	
	2000K Ω	
·)) Continuity check	20M Ω	250V rms
	2K Ω	
∇ Diode Test	2V	250V rms

MINI DIGITAL CLAMP TESTER

AC/DC CURRENT

Model **230**

AC · DC 20A ~ 200A
23mm ϕ CT



FEATURES

- Useful for DC A measurement for automobile service.
- Data-hold function. Especially useful when working in dark or hard to get areas.
- Accurate gearing mechanism for closing of CT.
- Ultra compact size.

SPECIFICATIONS

Measuring method	Dual integration mode
Display	3.5 digit LCD
Jaw opening capability	23mm ϕ
Overload indication	Blanking of all digits except MSD1
Maximum indication	1999
Low battery indication	"B" mark on LCD readout
Sampling	2 times/s
Limitation of circuit voltage	Less than AC/DC 500V
Withstanding voltage	AC 1000V, 1minute (Between outer case and core of CT)
Insulation resistance	10M Ω or more (Between internal circuit and core of CT)
Operation temperature	0°C to 40°C, <80% RH
Storage temperature	-10°C to 60°C, <70% RH
Power supply	SR-44(1.55V)×2 or LR-44×2
Power consumption	7mW
Battery life	SR-44: 30hours, LR-44: 16hours
Size	48(W)×146(H)×20(D)mm
Weight	Approx. 100g
Accessories	Soft case 1 Instruction manual 1 Batteries(LR-44)..... 2

AC Current

($\pm 23^{\circ}\text{C} \pm 5^{\circ}\text{C}$, 80% RH or less)

Range	Resolution	Accuracy (50/60Hz)	Accuracy (20~500Hz)	Max. current
20A	10mA	$\pm 1.0\%$ rdg ± 5 dgt	$\pm 1.5\%$ rdg ± 5 dgt	500A (peak)
200A	100mA	$\pm 1.5\%$ rdg ± 5 dgt (0~150.0A)	$\pm 2.0\%$ rdg ± 5 dgt (0~150.0A)	
		$\pm 2.5\%$ rdg ± 5 dgt (150.0~199.9A)	$\pm 3.5\%$ rdg ± 5 dgt (150.0~199.9A)	

DC Current

Range	Resolution	Accuracy	Max. current
20A	10mA	$\pm 1.0\%$ rdg ± 3 dgt	500A (peak)
200A	100mA	$\pm 1.5\%$ rdg ± 3 dgt (0~ ± 150.0 A)	
		$\pm 2.5\%$ rdg ± 3 dgt (± 150.0 ~ ± 199.9 A)	

MINI DIGITAL CLAMP TESTER

AC/DC CURRENT

Model **240**

AC · DC 0 ~ 20A/200A

30mm ϕ CT



FEATURES

- Ultra compact size and high accuracy AC/DC clamp-on tester.
- Data hold function. Especially useful when working in dark or hard to get areas.
- Wide range of current measurements from AC/DC 0.01A to 200A with 30mm ϕ CT.

SPECIFICATIONS

- Safety standard : Meets the requirements for double insulation to IEC 61010-1 (2001), IEC 61010-2-032 (2002) installation Category II 600V phase to earth, Category III 300V phase to earth.
- E.M.C. standard : The instrument meets EN 61326 (2004).
- Measuring method : Dual integration mode
- Display : 3.5 digit LCD, max. reading of 1999
- Accuracy : 23°C \pm 5°C, 80% RH or less

Range	Input range	Resolution	Accuracy	Max. input current	
AC	20A	0~19.99A	10mA	$\pm 1.5\%$ rdg ± 5 dgt (50/60Hz)	500A peak
			$\pm 2.0\%$ rdg ± 5 dgt (20~500Hz)		
	200A	0~150.0A	100mA	$\pm 1.5\%$ rdg ± 5 dgt (50/60Hz)	
				$\pm 2.0\%$ rdg ± 5 dgt (20~500Hz)	
				$\pm 3.0\%$ rdg ± 5 dgt (50/60Hz)	
				$\pm 4.0\%$ rdg ± 5 dgt (20~500Hz)	
DC	20A	0~ ± 19.99 A	10mA	$\pm 1.5\%$ rdg ± 3 dgt	
			$\pm 2.0\%$ rdg ± 3 dgt		
	200A	0~ ± 150.0 A	100mA	$\pm 3.0\%$ rdg ± 3 dgt	

- Jaw opening capability : 30mm ϕ
- Over range indication : Blanking of all digits except MSD1
- Low battery indication : "B" mark on LCD readout
- Sampling : 2 times/sec.
- Operating temperature : 0°C to 40°C, 80% RH max. (Non-condensing)
- Storage temperature : -10°C to 60°C, 70% RH max. (Non-condensing)
- Power supply : 1.55V (SR-44 or LR-44) \times 2
- Power consumption : Approx. 7mW
- Battery life : SR-44; 30 hours, LR-44; 16 hours
- Size : 44(W) \times 146(H) \times 20(D)mm
- Weight : Approx. 80g

- Accessories : Soft case 1
 Instruction manual 1
 Batteries(LR-44) 2

MINI DIGITAL CLAMP TESTER

AC/DC CURRENT

Model **250**

AC · DC 200A ~ 1000A
40mmφ CT



FEATURES

- Ultra compact size and high accuracy AC/DC clamp-on tester.
- Data hold function. Especially useful when working in dark or hard to get areas.
- Wide range of current measurements from AC/DC 0.1A to 1000A with 40mm φ CT.

SPECIFICATIONS

Safety standard	: Meets the requirements for double insulation to IEC 61010-1 (2001), IEC 61010-2-032 (2002) installation Category II 600V phase to earth, Category III 300V phase to earth.
E.M.C. standard	: The instrument meets EN 61326 (2004).
Measuring method	: Dual integration mode
Measuring function	: DC current, AC current
Display	: 3.5 digit LCD, max. reading of 1999
Range	: AC (50/60Hz)/DC 0~200A, 1000A
Ranging	: 2 ranges manual
Accuracy (at the center of CT)	: 23°C ± 5°C, 80% RH or less

	Range	Input range	Accuracy
DC	200A	0~199.9A	± 1.5% rdg ± 5 dgt
	1000A	0~1000A	
AC	200A	0~199.9A	± 1.5% rdg ± 5 dgt (50/60Hz)
	1000A	0~1000A	

Polarity	: Automatic no indication for positive polarity, minus (—) sign for negative polarity.		
Jaw opening capability	: 40mm φ		
Over range indication	: Blanking of all digits except MSD1		
Low battery indication	: "B" mark on LCD readout		
Sampling	: 2 times/sec.		
Data hold indication	: "DH" mark on LCD readout		
Operating temperature	: 0°C to 40°C, 80% RH max. (Non-condensing)		
Storage temperature	: -10°C to 60°C, 70% RH max. (Non-condensing)		
Power supply	: 1.55V (LR-44) × 2		
Power consumption	: Approx. 7mW (Continuous approx. 16 hours)	Accessories	: Soft case.....1
Size	: 68.5(W) × 175(H) × 23(D)mm		Instruction manual.....1
Weight	: Approx. 170g		Batteries2

DIGITAL CLAMP TESTER

AC/DC CURRENT

Model **260**

Average reading
55mmφ CT



FEATURES

- Low cost high performance and average reading AC/DC clamp tester.
- 4000 count full scale display.
- Additional AC/DC voltage, resistance, frequency test, continuity check and diode test function.
- Auto power off and data hold function.
- Convenient push switch for auto zero adjustment in DC current measurement.

SPECIFICATIONS

- AC conversion : Average sensing rms reading
- Safety standard : Meets the requirements for double insulation to IEC 61010-1 (2001), IEC 61010-2-032 (2002) installation Category III 600V phase to earth.
- E.M.C. standard : The instrument meets EN 61326 (2004).
- Withstanding voltage : AC 5500V, 1 minute (Between outer case and core of CT)
- Measuring method : Dual integration mode
- Jaw opening capability : 55mm φ
- Display : 3 1/2 digit LCD max. reading of 3999 and annunciators
- Over range indication : Blanking of all digits except MSD1 (Except AC/DC 2000A range)
- Low battery indication : "BAT" mark on LCD readout
- Sampling : 2 times/s
- Data hold indication : "DH" mark on LCD readout
- Auto power off : The meter is set to power off mode approx. 10 minutes after the power switch on.

- Operating temperature : 0°C to 40°C, <80%RH (Non-condensing)
- Storage temperature : -10°C to 60°C, <70%RH (Non-condensing)
- Power supply : 1.5V ("AAA" size R03)×2
- Power consumption and battery life : Approx. 14mW, 100 hours continuous.
- Size : 85(W)×240(H)×34(D)mm
- Weight : Approx. 350g
- Accessories : Carrying case.....1 Instruction manual.....1 Batteries.....2 Test lead.....1 set

Measuring ranges (23°C±5°C, < 80%RH) :

Range	Resolution	Accuracy	Max. input
~A (50/60Hz) = A Manual range	40A	0.01A	AC/DC 2000A
	400A	0.1A	
	2000A	1A	
~V (50/60Hz) = V Auto/Manual range	400mV	0.1mV	AC/DC 600V rms
	4V	0.001V	
	40V	0.01V	
	400V	0.1V	
	600V	1V	
Hz Frequency Auto range	100Hz	0.01Hz	AC/DC 600V rms
	1000Hz	0.1Hz	
	10kHz	0.001kHz	
	100kHz	0.01kHz	
	1000kHz	0.1kHz	
Ω (Resistance) Auto/Manual range	400Ω	0.1Ω	input protection
	4kΩ	0.001kΩ	
	40kΩ	0.01kΩ	
	400kΩ	0.1kΩ	
	4000kΩ	1kΩ	
Continuity check	400Ω	0.01Ω	± 1.5% rdg ± 8dgt
			± 3% rdg ± 10dgt
Diode test	3V	0.001V	Continuity beeper
			Approx. <40 Ω
			± 10% rdg ± 3dgt

DIGITAL CLAMP TESTER

AC/DC CURRENT

Model **270**

True rms reading
55mmφ CT



FEATURES

- Low cost high performance and true rms reading AC/DC clamp tester.
- 4000 count full scale display.
- Additional AC/DC voltage, resistance, frequency test, continuity check and diode test function.
- Auto power off and data hold function.
- Convenient push switch for auto zero adjustment in DC current measurement.

SPECIFICATIONS

- AC conversion : AC coupled true rms responding
- Safety standard : Meets the requirements for double insulation to IEC 61010-1 (2001), IEC 61010-2-032 (2002) installation Category III 600V phase to earth.
- E.M.C. standard : The instrument meets EN 61326 (2004)
- Withstanding voltage : AC 5500V, 1 minute (Between outer case and core of CT)
- Measuring method : Dual integration mode
- Jaw opening capability : 55mm φ
- Display : 3 1/2 digit LCD max. reading of 3999 and annunciators
- Over range indication : Blanking of all digits except MSD1 (Except AC/DC 2000A range)
- Low battery indication : "BAT" mark on LCD readout
- Sampling : 2 times/s
- Range : Auto or manual ranging, AC/DC current (Manual ranging)
- Data hold indication : "DH" mark on LCD readout

- Auto power off : The meter is set to power off mode approx. 10 minutes after the power switch on.
- Operating temperature : 0°C to 40°C, <80%RH (Non-condensing)
- Storage temperature : -10°C to 60°C, <70%RH (Non-condensing)
- Power supply : 1.5V ("AAA" size R03)×2
- Power consumption and battery life : Approx. 25mW, 90 hours continuous.
- Size : 85(W)×240(H)×34(D)mm
- Weight : Approx. 350g
- Accessories : Carrying case..... 1
Instruction manual..... 1
Batteries..... 2
Test lead..... 1
- Crest factor : <3 (0~50% of the range)
<2 (50~100% of the range)

Measuring ranges (23°C±5°C, < 80%RH) :

Range	Resolution	Accuracy	Max. input
~A (50/60Hz) = A Manual range	40A	0.01A	AC/DC 2000A
	400A	0.1A	
	2000A	1A	
~V (50/60Hz) = V Auto/Manual range	400mV	0.1mV	AC/DC 600V rms
	4V	0.001V	
	40V	0.01V	
	400V	0.1V	
	600V	1V	
Hz Frequency Auto range	100Hz	0.01Hz	AC/DC 600V rms
	1000Hz	0.1Hz	
	10kHz	0.001kHz	
	100kHz	0.01kHz	
	1000kHz	0.1kHz	
Ω (Resistance) Auto/Manual range	400Ω	0.1Ω	input protection
	4kΩ	0.001kΩ	
	40kΩ	0.01kΩ	
	400kΩ	0.1kΩ	
	4000kΩ	1kΩ	
Continuity check	400Ω	0.01Ω	± 1.5% rdg ± 8dgt
			± 3% rdg ± 10dgt
Diode test	3V	0.001V	Continuity beeper
			Approx. <40Ω
			± 10% rdg ± 3dgt

MINI DIGITAL CLAMP TESTER

AC/DC CURRENT AC/DC VOLTAGE RESISTANCE

Model **280**

meets safety Standard CAT.II 600V and CAT.III 300V

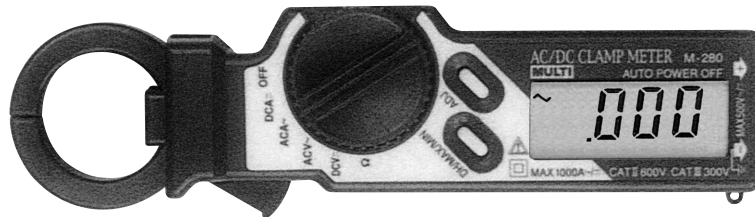

FEATURES

- 30mm ϕ CT window and ultra compact size
- Low cost and multi-function clamp tester.
- Data-hold function and auto power off.
- Conform to IEC safety requirements.
- Max. & Min.hold function
- One push zero adjust function for DC current range

SPECIFICATIONS

Safety standard	: Meets the requirements for double insulation to IEC 61010-1 (2001), IEC 61010-2-032 (2002), installation Category II 600V phase to earth, Category III 300V phase to earth.
E.M.C. standard	: The instrument meets EN 61326 (2004).
Measuring method	: Successive approximation mode
Display	: 4 digit LCD max. reading of 9999
Measuring range	: AC Current 1000A DC Current 1000A AC Voltage 500V DC Voltage 500V Resistance 600 Ω
Accuracy	: 23°C \pm 5°C 80%RH or less
AC Current (ACA)	: 0 ~ 600A \pm 1.5%rdg \pm 8dgt, 600.1 ~ 999.9A \pm 3%rdg \pm 8dgt
DC Current (DCA)	: 0 ~ 600A \pm 1.5%rdg \pm 6dgt, 600.1 ~ 999.9A \pm 3%rdg \pm 6dgt
AC Voltage (ACV)	: 0 ~ 500V \pm 1.0%rdg \pm 8dgt
DC Voltage (DCV)	: 0 ~ 500V \pm 1.0%rdg \pm 6dgt
Resistance (Ω)	: 0 ~ 600 Ω \pm 1.5%rdg \pm 8dgt
Jaw opening capability	: 30mm ϕ
Over range indication	: "OL" mark on LCD.
Low battery indication	: "B" mark on LCD
Data hold indication	: "DH" mark on LCD
Max. display function	: "Max" mark on display, indicating max. value during measurement.
Min. display function	: "Min" mark on display, indicating min. value during measurement.
O adjustment	: for DC current range, can make display to 0 by ADJ switch.
Sampling time	: 2 times/sec
Circuit voltage	: less than AC/DC 500V.
Withstanding voltage	: AC 3700V 1 minute max. (Between the core of CT and outer case)
Operating temperature	: 0°C to ~ 40°C < 80%RH (without condensing)
Storage temperature	: -10°C to ~ 60°C < 70%RH (without condensing)
Power supply	: SR-44(1.55V) \times 2 or LR-44 \times 2
Battery life	: SR-44, LR-44
Power Consumption	: Approx. 12mW
Size	: 44.5(W) \times 177(H) \times 24(D)mm
Weight	: Approx. 95g
Accessories	: Soft case 1 Instruction manual 1 Batteries, LR-44(1.55V) 2 Test Lead 1

TRUE-RMS AC/DC MINI CLAMP TESTER

Model **290 RMS**

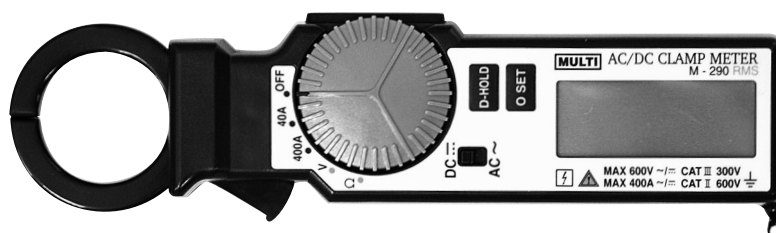

FEATURES

- 30mm ϕ CT window and compact size.
- 4000 count full scale display and true-rms reading for AC current.
- Conform to IEC safety requirements (IEC 61010-1, 61010-2-032 CAT II 600V).
- One push zero adjust function for DC current range.

SPECIFICATIONS

Measuring function	: AC/DC current, AC/DC voltage and Resistance
Measuring method	: Clamp CT
Jaw opening capability	: 30mm ϕ
Measuring ranges	: AC/DC 40A/400A manual, AC/DC 60V/600V auto, Resistance 0-1000 Ω
Change of measuring range	: By rotary switch
AC current detection	: True-rms detection
A/D conversion	: Successive approximation method
Display	: Max. 4000 count on LCD with annunciator
Over range indication	: "OL" mark on LCD
Data hold indication	: "DH" mark on LCD
Zero adjustment	: For DC current range, by "O ADJ" switch
Sampling rate	: 2 times/sec.
Low battery indication	: "B" mark on LCD
Circuit voltage	: less than AC/DC 500V
Operating temperature	: 0~40°C, < 80%RH (without condensation)
Storage temperature	: -10~60°C, < 70%RH (without condensation)
Withstanding voltage	: AC 3700V/1 minute between CT and outer case
Auto power off	: Approx. 10 minutes after power on
Power supply	: UM-4 \times 3
Dimension	: 44(W) \times 180(H) \times 24(D)mm
Accessories	: Soft Case, Test Lead, Batteries, Instruction Manual
Accuracy (2°C \pm 35°C, less than 80%RH)	

Range	Resolution	Accuracy
DC 40A	0.01A	$\pm 1.5\%rdg \pm 3dgt$
DC 400A	0.1A	$\pm 1.5\%rdg \pm 5dgt$
AC 40A	0.01A	$\pm 1.5\%rdg \pm 5dgt(50/60Hz)$
AC 400A	0.1A	$\pm 1.5\%rdg \pm 8dgt(50/60Hz)$
AC 60/600V	0.01V	$\pm 1.0\%rdg \pm 8dgt$
DC 60/600V	0.01V	$\pm 1.0\%rdg \pm 6dgt$
Ω	0.1 Ω	$\pm 1.5\%rdg \pm 8dgt$

Crest Factor : less than 2.5

DIGITAL CLAMP TESTER

AC/DC CURRENT/LEAKAGE

Model **600**

The world first high accurate AC/DC leakage current clamp-on tester.

AC/DC 0~200mA/2000mA/10A



FEATURES

- Wide application for process control and automotive service.
- The world first AC/DC leakage current clamp tester with 0.1mA resolution.
- The least influence from the external magnetic field and noise with double shielding CT.
- Memory function for maximum value and minimum value.
- For measurements of 4~20 mA current loop signal of transmission control.

SPECIFICATIONS

Safety standard	: Compliant with IEC 61010-1 (2001), IEC 61010-2-032 (2002) CAT II 300V.
Measuring method	: Dual integration method with true rms reading.
Measuring function	: DC current, AC current (true rms reading) with automatic zero adjustment, max. hold, min. hold, data hold, auto power off
Display	: 3.5 digit LCD, max. reading of 1999
Range	: AC/DC 200mA, 2000mA, 10A
Jaw opening capability	: 20mm ϕ
Sampling	: 1.6 times/s
Over range indication	: "OL" mark on LCD
Data hold indication	: "DH" mark on LCD
Low battery indication	: "B" mark on LCD
Resolution	: 0.1mA/1mA/0.01A
Accuracy	: DC current; $\pm 1\%$ rdg ± 5 dgt
(23°C ± 5 °C, 80% RH or less)	AC current (50/60Hz); $\pm 1\%$ rdg ± 5 dgt
Limitation of circuit voltage	: Less than AC/DC 300V
Withstanding voltage	: AC 2300V/1 minute max. between the core of CT and outer case.
Operating temperature	: 0°C ~50°C, <80% RH (Non-condensing)
Storage temperature	: -20°C ~60°C, <75% RH (Non-condensing)
Power supply	: 1.5V ("AA" size, UM-3) $\times 2$
Battery life	: 120 hours or more (Alkaline)
Auto power off	: The meter is set to power off mode approx. 10 minutes after the power switch on.
Size	: 76(W) \times 194(H) \times 30(D)mm
Weight	: Approx. 340g
Accessories	: Carrying case 1 Instruction manual 1 Batteries 2

PRECISE AC/DC LEAKAGE CURRENT TESTER

Model **700**

Model **730**

FEATURES

- High Sensitive for Low Range Leakage Current
- Suitable for Measurement of 4-20mA DC Controlled Circuit
- Lowest Influence from Magnetization & Terrestrial Magnetism
- Wide Measuring Ranges - up to DC 1000mA & AC 10A

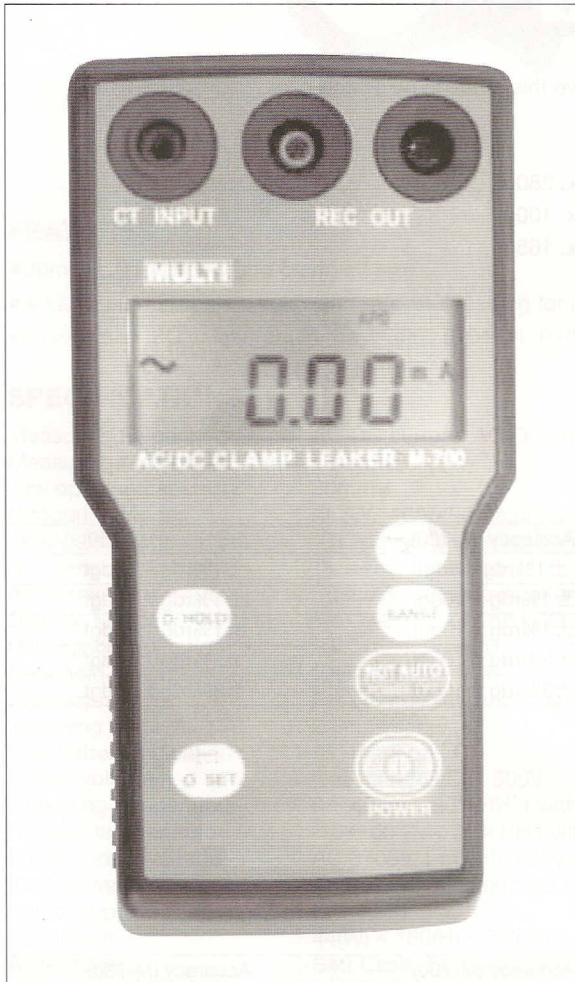

INSTRUMENT BODY

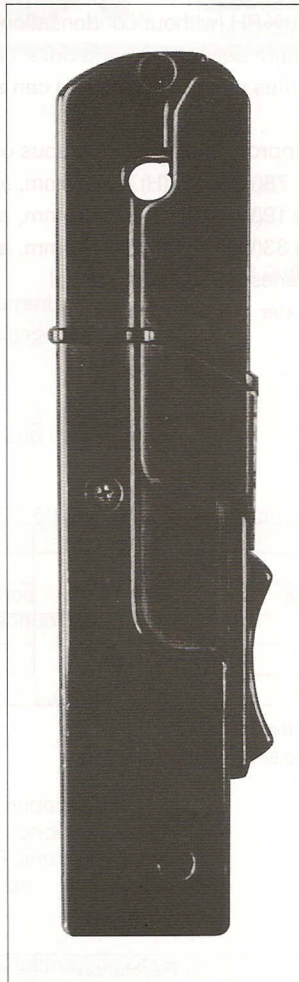

CTP-05DC For M-700



CTP-30DC For M-730

SPECIFICATIONS

Safety Standard	: IEC61010-1/61010-2-032 CAT II 600V or CAT III 300V
Measuring function	: AC/DC current
Measuring method	: Clamp CT (CTP-05DC:Slid/Hook Type)
Jaw opening capability	: 5mm ϕ (CTP-05DC), 30mm ϕ (CTP-30DC),
Measuring ranges	: DC 100mA/1000mA, AC 100mA/1000mA/10A (45Hz~65Hz)
AC current detection	: Average sensing
A/D conversion	: Dual integration method
Display	: Max. 2000 count on LCD with annunciator
Over range indication	: "OL" mark on LCD
Data hold indication	: "DH" mark on LCD
Zero adjustment	: For DC current range, by "0 ADJ" switch
Sampling rate	: 1 time/sec. for DC and 6 times/sec. for AC
Low battery indication	: "B" mark on LCD
Signal Output	: DC 100mV full scale to each range (output impedance: less than 10K Ω)
Circuit voltage	: less than AC/DC 500V
Operating temperature	: 0~50°C, < 85%RH (without condensation)
Storage temperature	: -10~60°C, < 70%RH (without condensation)
Withstanding voltage	: AC 3700V/1 minute between CT and outer case
Auto power off	: Approx. 10 minutes after power on and can absolve this function by switch
Power supply	: UM-4 \times 4
Consumption Current	: Approx. 9mA (approx. 200h for continuous use)
Dimension	: Display Part 78(W) \times 155(H) \times 32(D)mm, approx. 280g CT (CTP-05DC) 19(W) \times 133(H) \times 28(D)mm, approx. 100g CT (CTP-30DC) 33(W) \times 170(H) \times 24(D)mm, approx. 165g
Accessories	: Soft Case, Batteries, Instruction Manual
Option	: Cable for Recorder

Accuracy (23°C \pm 5°C, less than 85%RH)

DC Current

Range	Measuring Range	Resolution	Accuracy (M-700)	Accuracy (M-730)
100mA	0.1~ \pm 50.00mA	0.01mA	\pm 1%rdg \pm 5dgt	\pm 1%rdg \pm 10dgt
	\pm 50.01~ \pm 99.99mA		\pm 1%rdg \pm 10dgt	\pm 1%rdg \pm 10dgt
1000mA	1~ \pm 300mA	0.1mA	\pm 1%rdg \pm 10dgt	\pm 1%rdg \pm 10dgt
	\pm 300~ \pm 700mA		\pm 2%rdg \pm 10dgt	\pm 2%rdg \pm 10dgt
	\pm 700~ \pm 999.9mA		\pm 3%rdg \pm 10dgt	\pm 3%rdg \pm 10dgt

※ Influence of Terrestrial Magnetism : Less than \pm 0.5mA

※ Influence of Magnetization : Less than \pm 0.5mA by DC 1.5A on/off

※ Max Input Current : DC 1.5A

AC Current

Range	Measuring Range	Resolution	Accuracy (M-700)	Accuracy (M-730)
100mA	0~99.99mA	0.01mA	\pm 1%rdg \pm 10dgt (50/60Hz)	\pm 2%rdg \pm 10dgt (50/60Hz)
1000mA	0~999.9mA	0.1mA	\pm 1%rdg \pm 10dgt (50/60Hz)	\pm 2%rdg \pm 10dgt (50/60Hz)
10A	0~9.999A	0.001A	\pm 1%rdg \pm 10dgt (50/60Hz)	\pm 1%rdg \pm 10dgt (50/60Hz)

※ Max Input Current : AC 20A

DIGITAL CLAMP TESTER

AC CURRENT/LEAKAGE, AC CURRENT

Model HCL-3000

2000mA/20A/200A 3ranges
33mmφ CT



Safety Operation

for High Voltage Circuit

FEATURES

- Provides the wide range of current measurement from 1mA/10mA to 200A/500A (HCL-3000/HCL-5000).
- Useful one hand operation with the extended safety handle.
- Provides the safety current measurements on circuits having internal voltage from AC 80V to AC 7000V.
- Data-hold function is especially useful when working in dark or hard to get areas.
- AC 14kV (1minute) withstanding voltage between jaw core and handle.

Model HCL-5000

20A/200A/500A 3ranges
33mmφ CT



SPECIFICATIONS

Model	HCL-3000			HCL-5000		
Measuring method	Dual integration mode					
Display	3.5 digit LCD					
Range	2000mA	20A	200A	20A	200A	500A
Resolution	1mA	10mA	0.1A	10mA	100mA	1A
Accuracy ※	±2.0% rdg ±5 dgt(50/60Hz)			20/200A±2.0% rdg ±5 dgt(0~400A,50/60Hz) 500A±2.5% rdg ±5 dgt(50/60Hz)		
Jaw opening capability	33mmφ					
Overload indication	Blanking of all digits except MSD1					
Maximum indication	1999					
Low battery indication	"B" mark on LCD readout					
Sampling	2 times/s					
Limitation of circuit voltage	Less than AC 7000V (50/60Hz)					
Withstanding voltage	AC 14KV, 1minute (Between handle and core of CT)					
Insulation resistance	100MΩ or more (Between handle and core of CT)					
Operating temperature	0°C to 40°C, <80% RH					
Storage temperature	10°C to 60°C, <70% RH					
Power supply	UM-3(1.5V)×2					
Size	315(L)mm×54mmφ					
Weight	Approx.240g (Excluding batteries)					
Accessories	Carrying case……1 Instruction manual ……1 Batteries(UM-3)……2					
Optional accessory	Rubber handle cover					

※ 23°C±5°C、80% RH or less

DIGITAL CLAMP TESTER

AC CURRENT FOR HI-VOLTAGE CIRCUIT

Model HCL-5000D



FEATURES

- Wide Range Measurement of 0.1A~600A.
- Easy Operation - Push & Pull Auto Opening/ closing CT
- Safety Design & Function
- Auto Power off Function & Waterdrop Proof Structure

SPECIFICATIONS

- Measuring Function : AC line current
 Measuring Method : Dual integration mode
 Display : 3.5 digit LCD max. reading of 1999 with annunciators
 Measuring Range : 0~20A/600A manual (50Hz or 60Hz)
 Jaw opening Capability : ϕ 35mm
 Accuracy : 23°C \pm 5°C 80%RH or less

Range	Resolution	Accuracy
20A	0.01A	$\pm 2\%rdg \pm 8dgt$
600A	1A	0~400A : $\pm 2\%rdg \pm 8dgt$ 400A~600A : $\pm 3\%rdg \pm 8dgt$

- Data hold Function : "DH" mark on LCD
 Auto Power off : Automatically power off mode, approx. 5minutes after the power switch on.
 Sampling time : 2 times/sec
 Low Battery Indication : [B] mark on LCD.
 Operating Temperature : 0~40°C, less than 80%RH without condensing
 Power supply : Battery UM-4 \times 2
 Size & Weight : 70(W) \times 356(H) \times 68(D)mm, approx. 400gs.
 Accessories : Batteries, UM-4 2pcs.
 Carrying Case 1pce.
 Instruction manual 1pce.

Model HCL-1000D



FEATURES

- Safe AC current measurement by hot stick on circuit having internal voltage from AC 80V to AC 33KV.
- Provides wide range of current measurement from AC 0.01A to 600A.
- Peak Hold Function and with UNIVERSAL adapter for attachment of hot stick.
- Sealed to withstand water and contaminants.
- Provides the smooth and easy clamping for the cable with special made "PUSH TO OPEN" mechanism.

SPECIFICATIONS

- Measuring method : Dual integration mode
 Measuring function : AC line current
 Display : 3.5 digit LCD, max. reading of 1999 with annunciators
 Range : 0-20A / 600A (50/60Hz)
 Ranging : 2 manual ranging
 Accuracy : 23°C \pm 5°C, 80RH or less

Range	Resolution	Accuracy
20A	0.01A	$\pm 2.5\%rdg \pm 8dgt$
600A	1A	0~400A $\pm 2.5\%rdg \pm 8dgt$ 400A~600A $\pm 3\%rdg \pm 8dgt$

- Jaw opening capability : 35mm ϕ
 Low battery indication : "B" mark on LCD readout
 Over range indication : Blanking of all digits except MSD1 (Except 600A range)
 Sampling : 2 times/sec.
 Peak Hold Function : LED lamp is lightning when push the peak hold switch.
 Insulation resistance : 100M Ω or more by DC 1000V insulation tester (Between operation handle and core of CT)
 Withstanding voltage : AC 40kV, 1 minute (Between operation handle and core of CT)
 Limitation of circuit voltage : AC 80V to 23kV
 Power supply : 1.5V ("AAA" size) \times 2
 Constructure : Water resistance rank II (Japanese standard)
 Size : 70(W) \times 290(H) \times 32(D) mm (When retracted)
 Weight : Approx. 350gs including batteries
 Accessories : Carrying case 1
 Instruction manual 1
 Batteries 2

DIGITAL CLAMP TESTER

AC CURRENT FOR HI-VOLTAGE CIRCUIT

Model **HCL-9000S**



FEATURES

- Safe AC current measurement by optical isolated transmission method on circuit having internal voltage from AC 80V to AC 23kV.
- Provides wide range of current measurement from AC 0.01A to 600A.
- Useful analog signal data output for the recorder.
- Sealed to withstand water and contaminants.
- Provides the smooth and easy clamping for the cable with special made "PUSH TO OPEN" mechanism.

SPECIFICATIONS

Measuring method	: Dual integration mode
Measuring function	: AC line current
Structure	: Optically isolated between CT part and display/grip part.
Display	: 3.5 digit LCD, max. reading of 1999 with annunciators
Range	: 0~20A/600A (50/60Hz)
Ranging	: 2 manual ranging
Accuracy	: 23°C ± 5°C, 80RH or less

Range	Resolution	Accuracy
20A	0.01A	±2.5% rdg ±8 dgt
600A	1A	0~400A ±2.5% rdg ±8 dgt 400~600A ±3% rdg ±8 dgt

Jaw opening capability	: 35mm ϕ
Low battery indication	: CT part; Red LED lamp Display/grip part; "B" mark on LCD readout
Optical transmission	: Infrared LED and photo diode
Over range indication	: Blanking of all digits except MSD1 (Except 600A range)
Sampling	: 2 times/sec.
Data hold indication	: "DH" mark on LCD readout
Data output	: DC 100mA (Full count) DC 30mA (600A range) Data output accuracy; ±1% of full count Output impedance; 10k Ω or less
Insulation resistance	: 1000M Ω or more by DC 1000V insulation tester (Between operation handle and core of CT)
Withstanding voltage	: AC 46kV, 5 minute (Between operation handle and core of CT)
Power supply	: CT part; 1.5V ("AAA" size) × 3 Display/grip part; 1.5V ("AAA" size) × 2
Power consumption	: CT part; 5mA Display/grip part; 3mA
Constructure	: Water resistance rank II (Japanese standard)
Size	: 70(W) × 550(H) × 48(D)mm (When retracted) 70(W) × 1110(H) × 48(D)mm (When stretched)
Weight	: Approx. 800g
Accessories	: Carrying case 1 Instruction manual 1 Batteries 5

LEAKAGE CLAMP METER FOR ARRESTER

Model ALCL-40



GENERAL

This model ALCL-40 mainly measures very small leakage current of grounding line connected with Arrester, etc. The CT which is applied to this model is hardly affected by external magnetic field and therefore, model ALCL-40 can measure leakage current very accurately in high magnetic and electric field

SPECIFICATIONS

- 1) CT Sensor
 - Inside Diameter of CT : 40mm
 - Structure : Apart from Measuring Part
- 2) Measuring Part
 - Measuring Function : Leakage Current, Harmonic Current(Dominant & Third Wave)
 - Measuring Method : CT Clamp-on Method
 - Measuring Range : 0-300 μ A/3mA/30mA(3range manual)
 - Input Frequency : 45-60Hz(Dominant Wave Frequency)
 - AC Conversion : RMS Detection Method
 - A/D Conversion : Double Integration Method
 - Display : 3200 count max.,LCD
 - Sampling Rate : 2 times/second
 - Over Indication : "OL" on the display
 - Low Battery Indication : "B" sign on the display
 - Data Hold Function : "DH" sign on the display
 - Auto Power Off : Approx.10 minutes after power on
 - Other Function : Motor Drive Switch for CT open/close
- 3) General Specs.
 - Power Supply : AA size Alkaline battery \times 4
 - Operating Circuit Voltage : Less than 500V AC
 - Operating Temperature : 0~40 $^{\circ}$ C, less than 80%RH, w/o condensation
 - Storage Temperature : -10~60 $^{\circ}$ C, less than 70%RH, w/o condensation
- 4) Accuracy (23 $^{\circ}$ C)5 $^{\circ}$ C, less than 80%RH)
 - 4-1 AC Current

Range	Resolution	Accuracy(45~65Hz)	Max.Applicable Current
300 μ A	100nA(0.1 μ A)	1.2% \pm 8digit	40A rms
3mA	1 μ A(0.001mA)		
30mA	10 μ A(0.01mA)		

AC Conversion : RMS Detection Method

Crest Factor : <3 (0~50% of the range)

<2 (50~100% of the range)

4-2 Harmonic Current(Dominant Current, 3rd Harmonic Current)

Detection Method : Automatic Tuned Filter

Min. Dominant Current Input : more than 3% of each range

Accuracy : (1% \pm 5digit) \pm (AC Current Accuracy) – (Tolerance influenced by adjacent frequency)

* In case that the harmonic current is more than 4% of the dominant wave
Tolerance influenced by adjacent frequency : 1.5%

DIGITAL HARMONICS TESTER

Model **HWT-300**

Measurement for harmonics on current



FEATURES

- The best monitor for determining harmonic distortion levels in the field use.
- Measures harmonics current flow up to the 25th harmonic.
- Small size, light weight, low cost.
- Easy to use with clamp-on operation.

SPECIFICATIONS

General Specification

Measuring method	: Dual integration mode with true rms reading
Measuring function	: Load current & leakage current (All pass mode), harmonics current (Harmonics mode)
Display	: 3.5 digit LCD, max. reading of 4000
Range	: 0~400mA/4A/40A/300A
Input frequency	: 45Hz~65Hz
Jaw opening capability	: 40mm ϕ
Over range indication	: "OL" mark on LCD readout
Low battery indication	: "BAT" mark on LCD readout
Sampling time	: 2 times/s
Data hold indication	: "DH" mark on LCD readout
Data output	: DC 100mV for full scale (400mA/4A/40A range) DC 75mV for full scale (300A range) Accuracy; $\pm 1\%$ (Full scale) Output impedance; 10k Ω or less
Affection of magnetic fields	: Less than 3mA (100A nearby conductor)

Auto power off	: The meter is set to power off mode approx. 10 minutes after the power switch on.
Withstanding voltage	: AC 2200V, 1 minute max. (Between the core of CT and outer case)
Limitation of circuit voltage	: Less than AC 600V
Operating temperature	: 0 °C \pm 40 °C, <80%RH (Non-condensing)
Storage temperature	: -10 °C \pm 60 °C, <70%RH (Non-condensing)
Power supply	: 1.5V ("AAA" size, R03) \times 3 or AC adaptor (Optional)
Power consumption	: Approx. 13mA
Battery life	: Approx. 50 hours (Manganese battery)
Size	: 68(W) \times 207(H) \times 33(D)mm
Weight	: Approx. 430g
Accessories	: Carrying case.....1 Instruction manual.....1 Batteries3

Measuring Mode

1. All pass mode accuracy : 400mA, 4A, 40A range; $\pm 1\%$ rdg ± 8 dgt
300A range; $\pm 1\%$ of full scale

2. Harmonics mode
 Measuring method : Synchronous filter
 Measurable harmonics : Fundamental frequency to 25th harmonics
 Minimum fundamental input current : More than 5% of full scale in each range
 Accuracy (23 °C \pm 5 °C) : 1% rdg ± 5 dgt
 Error by neighboring harmonics

Harmonics	※ Harmonics component ratio of the neighboring frequency	Typical accuracy
5th	65%	$\pm 3\%$ rdg ± 5 dgt
7th	41%	$\pm 3.5\%$ rdg ± 5 dgt
11 · 13th	20%	$\pm 4\%$ rdg ± 5 dgt
15~23rd	10%	$\pm 5\%$ rdg ± 5 dgt

※ For example : The neighboring frequency of 5th harmonic means 4th harmonic and 6th harmonic. If the harmonic component ratio of 4th harmonic and 6th harmonic is 65%, the typical accuracy will be $\pm 3\%$ rdg ± 5 dgt.

DIGITAL HARMONICS TESTER

Model **HWT-301**

Harmonics measurements on current and voltage for the electric line



- The best monitor for determining harmonic distortion levels in the field use.
- Measures harmonics voltage and harmonics current flow up to the 25th harmonic.
- Measures leakage current, load current, voltage with true rms reading.
- Small size, light weight, low cost.
- Easy to use with clamp-on operation.

DIGITAL HARMONICS TESTER

Model **HWT-301**

SPECIFICATIONS

General Specification

Measuring method	: Dual integration mode with true rms reading
Measuring function	: Load current, leakage current, harmonics current, voltage, harmonics voltage, resistance
Safety standard	: Meets the requirements for double insulation to IEC 61010-1 (2001), IEC 61010-2-032 (2002) installation Category II 600V phase to earth, Category III 300V phase to earth.
E.M.C. standard	: The instrument meets EN 61326 (2004).
Affection of magnetic fields	: Less than 3mA (100A nearby conductor)
Display	: 3 ³ / ₄ digit LCD, max. reading of 4000
Input frequency	: 45Hz~65Hz
Sampling time	: 2 times/s
Over range indication	: "OL" mark on LCD readout
Low battery indication	: "BAT" mark on LCD readout
Data hold indication	: "DH" mark on LCD readout
Jaw opening capability	: 40mm ϕ
Withstanding voltage	: AC 3700V/1 minute max. (Between the core of CT and outer case)
Operating temperature	: 0 °C \pm 40 °C, <80%RH (Non-condensing)
Storage temperature	: -10 °C ~60 °C, <70%RH (Non-condensing)
Power supply	: 1.5V ("AAA" size, R03) \times 3
Power consumption	: Approx. 13mA
Auto power off	: The meter is set to power off mode at approx. 20 minutes after the power switch on.
Battery life	: Approx. 50 hours continuous (By manganese battery)
Size	: 70(W) \times 223(H) \times 34(D)mm
Weight	: Approx. 440g
Accessories	: Batteries3 Carrying case1 Instruction manual1

Measuring Ranges

Note : Electrical characteristic (18°C ~ 28°C, 80%RH max)

All pass mode

AC Current (True rms)

Range	Resolution	Accuracy
400mA	0.1mA	$\pm 1.0\%$ rdg ± 8 dgt
4A	1mA	
40A	10mA	
300A	100mA	$\pm 1.0\%$ rdg $\pm 1\%$ of full scale

AC Voltage (True rms)

Range	Resolution	Accuracy	Input impedance	Max. input voltage
400mV	0.1mV	$\pm 1.0\%$ rdg ± 8 dgt	>10M Ω	AC 250V rms
400V	100mV			AC 450V rms

Resistance

Range	Resolution	Accuracy	Max. test current	Open circuit voltage
4000 Ω	1 Ω	$\pm 1.0\%$ rdg ± 8 dgt	70 μ A	1.5V

※ Input protection : 400V rms

Harmonics Mode

Measuring method	: Synchronous filter
Measurable harmonics	: Fundamental frequency to 25th harmonics.
Minimum fundamental input	: More than 5% of full scale in each range.

Harmonics	Accuracy (In case of more than 4% harmonics are included against fundamental input)
1~9th	($\pm 1\%$ rdg ± 5 dgt) \pm (Basic accuracy of ACA or ACV) — (Error by neighboring harmonics)
10~19th	($\pm 2\%$ rdg ± 5 dgt) \pm (Basic accuracy of ACA or ACV) — (Error by neighboring harmonics)
20~25th	($\pm 5\%$ rdg ± 5 dgt) \pm (Basic accuracy of ACA or ACV) — (Error by neighboring harmonics)

HARMONICS TESTER

Model **HWT-1000**

The HWT-1000 is a harmonics tester that measures harmonic components on a commercial power line and performs such measurements as that of the direction of generation of these components. It has one channel each of voltage and current input, and the PT ratio and CT ratio of each can be set, enabling first order conversion of the measured value. The HWT-1000 is capable of measurements from the fundamental frequency up to the 40th harmonic.

Measurements can be made on single-phase, single-phase/3-wire, three-phase/3-wire, and three-phase/4-wire power lines, and measurement items are as follows.

- Measurement and digital display of voltage/current values, active/reactive power, phase/power factor
- Waveform display of voltage/current
- Harmonic component analysis and display for voltage/current
 - ★ Voltage/current harmonic spectrum display
 - ★ Harmonic power/direction spectrum display
 - ★ List of content and phase of each harmonic
 - ★ List of rms value and phase of each harmonic

Measurement results can be stored within the HWT-1000 and can also be printed on a printer. Because the current input is made using a clamp-type current transducer, it is possible to make measurements without disturbing live wires.



HARMONICS TESTER

Model **HWT-1000**

SPECIFICATIONS

Functional Specification

Input Section

Voltage Input

Number of input channels : 1
 Input ranges : 150/500 Vrms
 Usable input ranges : 150-Vrms range: 10 to 160 Vrms
 500-Vrms range: 30 to 500 Vrms
 Range switching : Manual
 Input impedance : 1MΩ

Current Input

Number of input channels : 1
 Input ranges : 0.5/5/50/300 Arms
 Usable input ranges : 0.5-Arms range: 0.05 to 0.6 Arms
 5-Arms range: 0.5 to 6 Arms
 50-Arms range: 5 to 60 Arms
 300-Arms range: 30 to 300 Arms
 Range switching : Manual
 Input method : Current transducer clamp
 Fundamental frequency input range : 45 to 65 Hz
 Sync method : Voltage-input priority
 (Syncing on current alone is also possible)

Measurement Section

Measurement method : True rms measurement
 Maximum input peak voltage/current : 1.7 times each range value
 Basic measurement accuracy (At 23°C ±5 °C and 80% maximum relative humidity) : (See table below)

Measurement function	Range	Resolution	Accuracy
AC current	0.5A	0.1mA	± 1% rdg ± 5 digits
	5A	1mA	
	50A	10mA	
	300A	100mA	0 to 200A : ±1.0 rdg ±5 digits 200A to 250A : -3.0 rdg ±5 digits 250A to 300A : -3.0 rdg ±5 digits
AC voltage	150V	0.1V	± 1% rdg ± 5 digits
	500V	0.1V	± 1% rdg ± 5 digits

Harmonic Analysis Section

Range of analyzed orders : Fundamental to 40th harmonic
 Analysis results displayed items : Voltage/current value and Vn-In phase for each order
 Voltage/current value content and Vn-In phase for each order
 Analysis reference phase : Voltage (Or current for current-only input)

Analysis Level Accuracy (For a fundamental input level of 30% of the input range)

Voltage input Fundamental to 10th harmonic : ± 1.5% of rdg ± 3 digits
 11th to 20th harmonic : ± 5% of rdg ± 3 digits
 21st to 30th harmonic : ± 10% of rdg ± 3 digits
 31st to 40th harmonic : ± 20% of rdg ± 3 digits
 Current input Fundamental to 10th harmonic : ± 3% of rdg ± 3 digits
 11th to 20th harmonic : ± 6% of rdg ± 3 digits
 21st to 30th harmonic : ± 15% of rdg ± 3 digits
 31st to 40th harmonic : ± 30% of rdg ± 3 digits

HARMONICS TESTER

Model HWT-1000

Analysis phase accuracy (For a fundamental input level of 30% of the input range)	
1st to 10th harmonic	: ± 3 deg
11th to 20th harmonic	: ± 5 deg
21st to 30th harmonic	: ± 15 deg
31st to 40th harmonic	: ± 30 deg

Analysis results display (Spectrum display for each order level)	
	List display of content and phase for each order
	List display rms value and phase for each order

Power Measurement Section

Measurement display items	: Active power, reactive power, phase, power factor
Analysis results display	: Power/direction spectrum display for each order harmonic

Waveform Display Section

Analog display	: One-period display voltage and current
Digital display	: Distortion factor of voltage/current Peak voltage/current values

Measurement Data Processing Functions

Measurement data output	: Output to an external printer via RS-232c
Measurement data storage	: 100 set
Measurement data printing	: Printing of selected measurement data Printing of held measurement data

Other Functions

A/D conversion resolution	: 16 bits
Sampling rate	: 256 samples/period
Averaging	: Selectable: 1, 2, 4, 8, 16 periods
Power supply polarity correction	: Automatically corrected by fundamental voltage/current phase difference.
3-phase capability	: Power and phase compensation provided for 3-phase, 3-wire lines.
Automatic power-off function	: In the P-OFF mode, power is shut off after approximately 15 minutes with no key operations.

General Specifications

Power supply	: Ni-CD battery drive (Charger)
Continuous operation	: Approx. 16 hr (Measurement only) after a full battery charge.
Operating environment	: Temperature: 5 to 35°C Humidity : 80% max. relative humidity (Non-condensing)
Storage environment	: Temperature: -10 to +50°C Humidity : 70% max. relative humidity (Non-condensing)
Withstanding voltage	: 2000 VAC for 1 minute (Approximate sinewave at 50/60 Hz between all measurement terminals and case)
Insulation resistance	: 10 M Ω min. (Measured using a 500-VDC insulation tester)
Size	: 200 (W) \times 100 (H) \times 81 (D) mm (Main unit only)
Weight	: Approx. 1.7kg (Main unit only)
Accessories	: Carrying case Instruction manual Voltage pickup cable set Current detection CT
Optional accessories	: Charger (Optional made) BS-80TSL Printer LAD-1000H High-voltage clamp adaptor

THERMAL PRINTER

FOR HWT-1000 HARMONICS TESTER

Model **BS-80TSL**

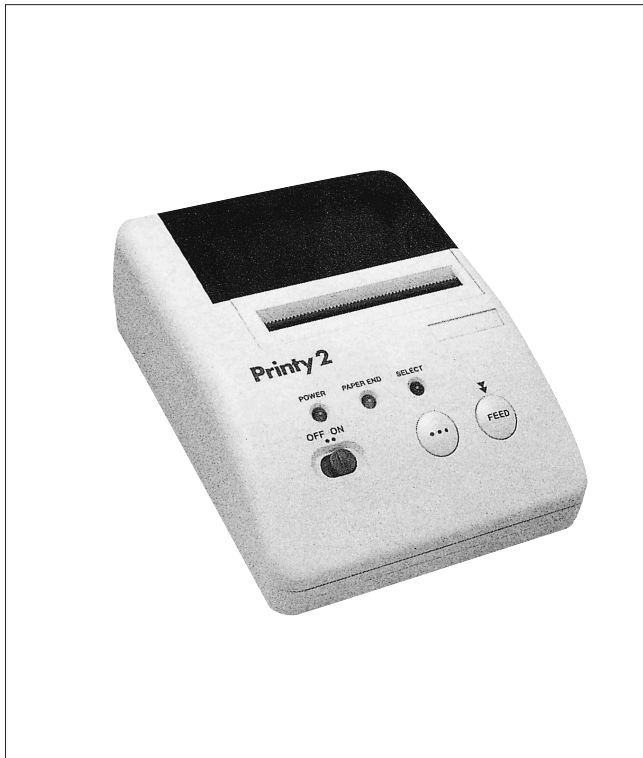

FEATURES

- Simple design and compact size.
- High speed printing for the character and graph.
- Automatic loading mechanism for the setting of printing paper.
- Convenient battery operation for the field use.

SPECIFICATIONS

Printing method	: Thermal serial dot matrix
Printing speed	: 41 character/sec. (1.86 line/sec.)
Printing width	: 63mm
Character size (selectable)	: 16 × 8 dot matrix (3.4 × 1.2mm) 16 × 16 dot matrix (3.4 × 2.4mm) 16 × 32 dot matrix (3.4 × 4.8mm)
Number of dot for graph printing	: 16 × 448 dot/line
Printing paper	: 79.5 ± 8.5mm(W) × 15m(L), 38mm φ (Parts number BS-80-15)
Power supply	: 1.5V ("AA" size or UM-3) × 4 or AC adaptor (Output DC 6V/1500mA)
Power consumption	: 1A (Typical), 4.2A (Peak)
Operating temperature	: 0°C to 40°C, 80%RH max. (Non-condensing)
Size	: 134(W) × 60(H) × 180(D)mm
Weight	: Approx. 550g
Optional accessory	: AC adaptor

ANALOG INSULATION RESISTANCE TESTER

Single Scale Indicator for 3 Range Insulation Measurements

Model **MIS-1A**

50V/10M Ω
125V/20M Ω
250V/50M Ω

Model **MIS-2A**

125V/ 20M Ω
250V/ 50M Ω
500V/100M Ω

Model **MIS-3A**

125V/ 20M Ω
250V/ 50M Ω
1000V/2000M Ω

Model **MIS-4A**

250V/ 50M Ω
500V/ 100M Ω
1000V/2000M Ω



FEATURES

- The single and fluorescent scale indicator for 3 ranges insulation measurements enabled easy observation. Especially useful when working in dark place.
- Hand free and continuous measurements with custom made switch.
- Safe design with built in automatic discharging function for any capacitors present in the circuit.
- The voltage in the circuit can be pre-checked without any switch operation for safe insulation measurements.
- Compact, light weight and heavy duty rugged case.

ANALOG INSULATION RESISTANCE TESTER

SPECIFICATIONS

Function	: Insulation resistance, AC voltage, battery check
Meter movement	: 100 μ A, 870 Ω , taut band meter.
Safety standard	: Meets the requirements for double insulation to IEC 61010-1 (2001), IEC 61010-2-032 (2002) installation Category II, 600V phase to earth.
E.M.C. standard	: The instrument meets EN 61326 (2004)
Constructional standard	: In accordance with IEC 1557-2 or JIS C1302(1994)
Insulation resistance	: DC 500V-50M Ω or more (MIS-1A, MIS-2A) DC 1000V-50M Ω or more (MIS-3A, MIS-4A)
Withstanding voltage	: AC 3700V, 1 minute (Between input terminal and outer case)
Overload protection	: 120% of the highest nominal output voltage (10sec.)
Battery check	: DC 6.3V~9.5V
Low battery limit	: DC 6.3V
Temperature characteristics (0~40 $^{\circ}$ C)	: \pm 5%rdg of specified accuracy
Operating temperature	: 0 $^{\circ}$ C to 40 $^{\circ}$ C, 80% RH max.(Non-condensing)
Storage temperature	: -10 $^{\circ}$ C to 60 $^{\circ}$ C 80% RH max.(Non-condensing)
Power supply	: 1.5V("AA" size, R6) \times 6
Size	: 170(W) \times 105(D) \times 54(H)mm
Weight	: Approx.330g(Excluding batteries)
Accessories	: Line test lead ¹ Earth test lead 1 Batteries 6 Test lead case 1 Belt 1 Instruction manual 1
Optional accessory	: Remote switch test lead

Measuring Ranges and Technical Data

Insulation resistance measurement

Model	MIS-1A	MIS-2A	MIS-3A	MIS-4A
Rated voltage & effective measuring range	50V-10M Ω 125V-20M Ω 250V-50M Ω	125V- 20M Ω 250V- 50M Ω 500V-100M Ω	125V-20M Ω 250V-50M Ω 1000V-2000M Ω	250V-50M Ω 500V-100M Ω 1000V-2000M Ω
Center scale	0.2M Ω /0.5M Ω /1M Ω	0.5M Ω /1M Ω /50M Ω	0.5M Ω /1M Ω /2M Ω	1M Ω /2M Ω /50M Ω
Minimum measurable resistance at rated voltage	0.05 M Ω 0.125M Ω 0.25 M Ω	0.125M Ω 0.25M Ω 0.5 M Ω	0.125M Ω 0.25M Ω 1M Ω	0.25M Ω 0.5M Ω 1M Ω
Rated current	1mA+20% - 0%			
Maximum no-load voltage	Rated voltage+30%-0%			
Short circuit current	<2mA			

Accuracy

Rated voltage	DC 50V	DC 125V	DC 250V	DC 500V	DC 1000V
First effective range	0.01M Ω ~5M Ω \pm 5%rdg	0.02M Ω ~10M Ω \pm 5%rdg	0.05M Ω ~20M Ω \pm 5%rdg	0.1M Ω ~50M Ω \pm 5%rdg	2M Ω ~1000M Ω \pm 5%rdg
Second effective range	0.005M Ω ~ 0.01M Ω 5M Ω ~10M Ω \pm 10%rdg	0.01M Ω ~ 0.02M Ω 10M Ω ~20M Ω \pm 10%rdg	0.02M Ω ~ 0.05M Ω 20M Ω ~50M Ω \pm 10%rdg	0.05M Ω ~ 0.1M Ω 50M Ω ~100M Ω \pm 10%rdg	1M Ω ~2M Ω 1000M Ω ~ 2000M Ω \pm 10%rdg
	10M Ω ~50M Ω \pm 30%rdg	20M Ω ~100M Ω \pm 30%rdg	50M Ω ~100M Ω \pm 30%rdg		

AC voltage measurement (50/60Hz)

Range	Accuracy	Input impedance	Maximum input voltage
AC 600V	\pm 2.5% of full scale	Approx.1.5M Ω	AC 600V rms

DIGITAL INSULATION RESISTANCE TESTER

For 3 Range Insulation Measurements

Model MIS-2D

125V/ 20M Ω
250V/ 50M Ω
500V/100M Ω

Model MIS-3D

250V/ 50M Ω
500V/ 100M Ω
1000V/2000M Ω

Model MIS-4D

125V/ 20M Ω
250V/ 50M Ω
1000V/2000M Ω



FEATURES

- The big digital and bargraph LCD display with back light enabled easy observation. Especially useful when working in dark place.
- Hand free and continuous measurements with custom made switch.
- Safe design with built in automatic discharging function for any capacitors present in the circuit.
- The voltage in the circuit or capacitor can be checked by warning lamp for safe insulation measurements.
- Data hold and auto power off function.
- Compact, light weight and heavy duty rugged case.

DIGITAL AND BARGRAPH DISPLAY INSULATION TESTER

SPECIFICATIONS

Function	: Insulation resistance, AC voltage
Display	: 3½ digit LCD with bargraph display, max. reading of 3200 count and annunciators
Response time	: Less than 5 sec. (Auto ranging)
Data hold indication	: "DH" mark on LCD readout
Infinity indication	: "OL(∞)" mark on LCD readout (Over 3200 count)
Safety standard	: Meets the requirements for double insulation to IEC 61010-1 (2001), IEC 61010-2-032 (2002) installation Category II, 600V phase to earth.
E.M.C. standard	: The instrument meets EN 61326 (2004)
Constructional standard	: In accordance with IEC 1557-2 or JIS C1302 (1994)
Insulation resistance	: DC 500V-50MΩ or more (MIS-2D) DC 1000V-50MΩ or more (MIS-3D, MIS-4D)
Withstanding voltage	: AC 3700V, 1 minute (Between input terminal and outer case)
Overload protection	: 120% of the highest nominal output voltage (10sec.)
Low battery indication	: "B" mark on LCD readout
Temperature characteristics (0~40°C)	: ±5%rdg of specified accuracy
Operating temperature	: 0°C to 40°C, 80% RH max. (Non-condensing)
Storage temperature	: -10°C to 60°C, 80% RH max. (Non-condensing)
Power supply	: 1.5V("AA" size, LR6)×6
Size	: 170 (W)×105(D)×54(H)mm
Weight	: Approx. 365g (Excluding batteries)
Accessories	: Line test lead 1 Earth test lead 1 Batteries 6 Test lead case 1 Belt 1 Instruction manual 1
Optional accessory	: Remote switch test lead

Measuring Ranges and Technical Data

Insulation resistance measurement

Model	MIS-2D	MIS-3D	MIS-4D
Rated voltage & effective measuring range	125V-20MΩ 250V-50MΩ 500V-100MΩ	250V- 50MΩ 500V- 100MΩ 1000V-2000MΩ	125V-20MΩ 250V-50MΩ 1000V-2000MΩ
Minimum measurable resistance at rated voltage	0.125MΩ 0.25MΩ 0.5MΩ	0.25MΩ 0.5MΩ 1MΩ	0.125MΩ 0.25MΩ 1MΩ
Rated current	1mA+20%-0%		
Maximum no-load voltage	Rated voltage+30%-0%		
Short circuit current	<2mA		

Accuracy

Rated voltage	DC 125V	DC 250V	DC 500V	DC 1000V
Measuring range	0~20MΩ~0L(∞)	0~50MΩ~0L(∞)	0~100MΩ~0L(∞)	0~2000MΩ~0L(∞)
First effective range	0.02MΩ~10MΩ <±5%rdg	0.05MΩ~20MΩ <±5%rdg	0.1MΩ~50MΩ <±5%rdg	2MΩ~1000MΩ ±5%rdg
Second effective range	0.01MΩ~0.02MΩ 10MΩ~100MΩ <±10%rdg	0.02MΩ~0.05MΩ 20MΩ~100MΩ <±10%rdg	0.05MΩ~0.1MΩ 50MΩ~100MΩ <±10%rdg	1MΩ~2MΩ 1000MΩ~2000MΩ <±10%rdg
Other range		100MΩ~0L(∞) Not specified		2000MΩ~0L(∞) Not specifind

AC voltage measurement (50/60Hz)

Range	Accuracy	Input impedance	Maximum input voltage
AC 600V	±2.5% of full count	Approx.20MΩ	AC 600V rms

CLAMP EARTH TESTER

Model **MET-1**

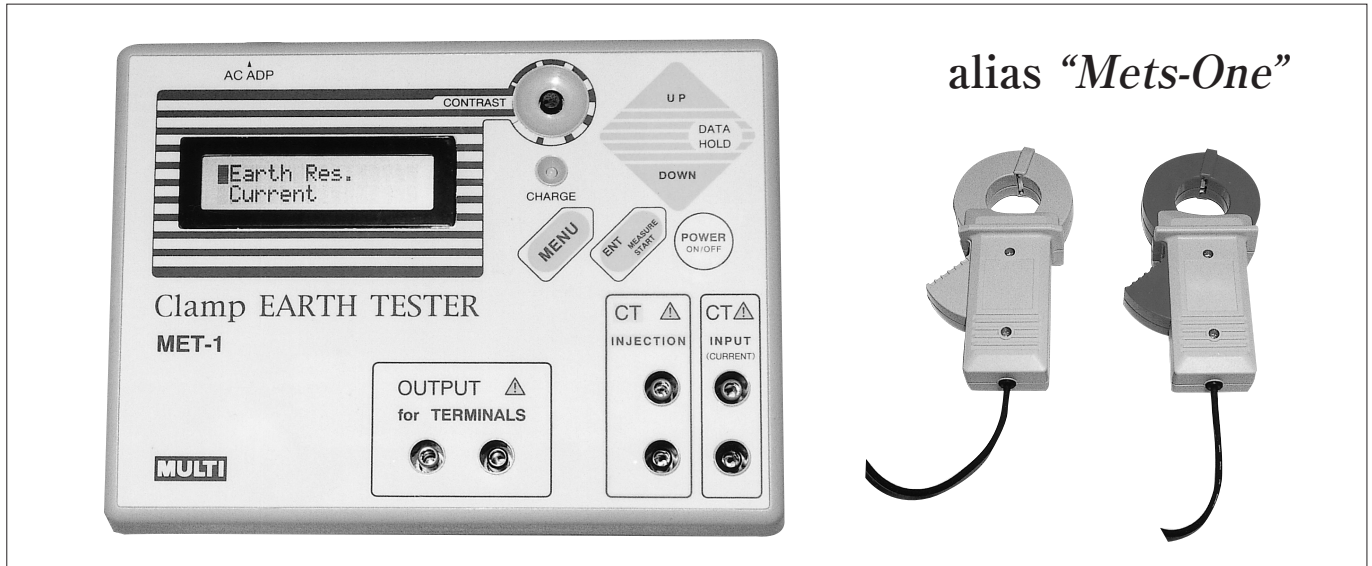

FEATURES

- Completely different method from the ordinary Earth Testers.
- Just clamping two CTs to the earthing conductor and no need to use auxiliary earth rod.

GENERAL

This Clamp Earth Tester Model MET-1 measures the earth resistance by using two clamp CTs without disconnecting the earthing conductor and without using auxiliary ground rod and can measure only the objective earth resistance without any influence from other conductors.

APPLICATIONS FOR MEASUREMENT OF EARTH RESISTANCE

1. Outer case & iron stand of extra-high tension cable and high voltage appliance.
2. Lightning arrester.
3. Transformer at output end for the extra-high voltage measuring appliance.
4. Confirming the grounding of the conductors for equipotential bonding.
5. Static electricity prevention equipment & appliance.
6. Multiple earth.

Also, this new instrument has another function for the measurement of leakage current.

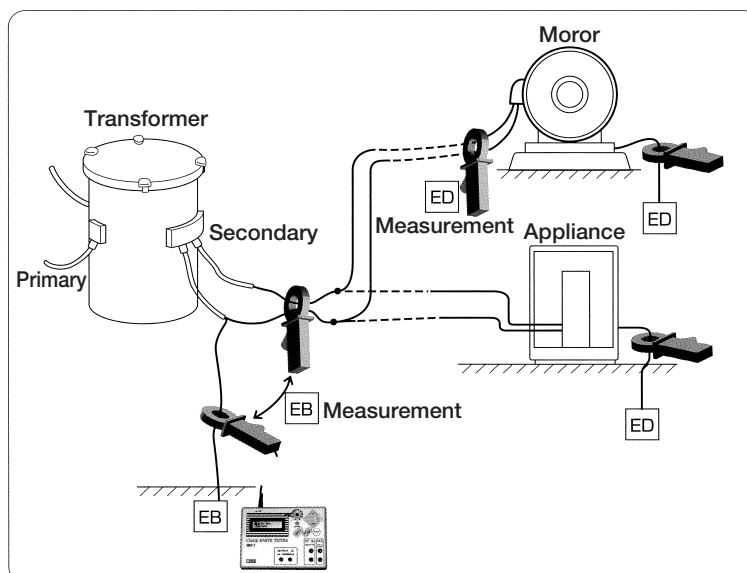

CLAMP EARTH TESTER

AC CURRENT AC/DC VOLTAGE RESISTANCE

Model **MET-1**

SPECIFICATIONS

Measuring function	: Earth Resistance, AC Current (Line & Leakage)
Measuring method	: Dual integration mode, Clamping Two CTs
Display	: LCD, 16 letters/characters X 2 lines with contrast adjustor
Safety standard	: Meets the requirements for double insulation to IEC 61010-1 installation Category II. 600V phase to earth.
Sampling	: Approx. 2 times/second for AC current
Measuring Time	: Approx. 30 second for earth resistance
Over range indication	: "OVER" on LCD readout both for AC current & earth resistance
Low battery indication	: "B" mark on LCD readout
Auto power off	: The meter is set to power off mode, approx. 5 minutes after the power switch on.
Data hold function	: "DH" mark on LCD readout.
Accuracy	: 23°C ± 5°C, 80%RH max.

Earth Resistance

Range	Resolution	Accuracy
200 Ω	0.1 Ω	0 ~ 10 Ω ± 0.2 Ω
		10 ~ 50 Ω ± 1.0 Ω
		50 ~ 200 Ω ± 5.0 Ω

AC Current (Max. applicable current : F10A rms)

Range	Resolution	Accuracy
200mA	0.1mA	2% rdg ± 8 dgt
2000mA	1mA	
10A	0.01A	

CT for detection	: 340mm
CT for superposition	: 340mm, auto sweep 4KHz ~ 400KHz superposing level : approx.160mVp
Storage temperature	: -10°C ~ 60°C, <80% RH without condensation
Operating temperature	: 0°C ~ 40°C, <80% RH without condensation
Circuit voltage	: less than 500V
Withstanding voltage	: AC 3700V, 1minute between operation handle and CT core. AC 2300V, 1minute between supply source and body case of the instrument.
Power Supply	: AC100V ~ 240V (50/60Hz) with adaptor Internal Ni-Cd battery (1.2V X 5)
Battery life	: 450 times measurement under full charged condition (according to the times of charging and discharging).
Size & weight	
CT for detection	: 90.5(W) X 165(H) X 38(D)mm, approx. 460g
CT for superposition	: 90.5(W) X 165(H) X 38(D)mm, approx. 440g
Instrument body	: 190(W) X 140(H) X 42(D)mm, approx. 800g
Standard accessories	: Detection Clamp CT 1 Superposition Clamp CT..... 1 AC Adaptor 1 Carrying case 1 Instruction Manual 1 Subsidiary lead wire 1

CLAMP EARTH TESTER

Model MET-2

FEATURES

- Completely different method from the ordinary Earth Resistance Testers.
- Just clamping two CTs to the earth conductor and no need to use auxiliary earth rods.

GENERAL

This Clamp Earth Tester Model MET-ÇQ measures the earth resistance by using two clamp CTs without disconnecting the earth conductor and without using auxiliary ground rod and can measure only the objective earth resistance without any influence from other conductors.

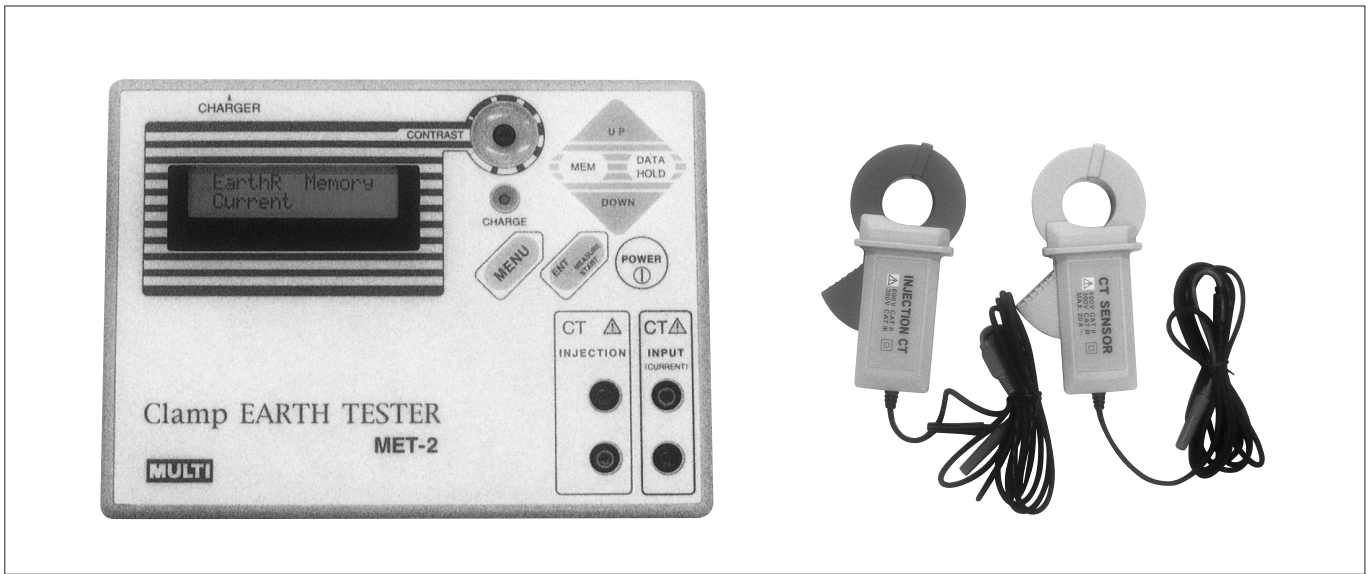

APPLICATIONS FOR MEASUREMENT

1. Earth resistance for outer case of extra-high voltage equipment.
2. Earth resistance for arrester.
3. Earth resistance for secondary side of the extra-high voltage transformer.
4. Earth resistance for the conductors for equipotential bonding.
5. Static electricity protection equipment & appliance.
6. For single and multi-grounded systems.
7. Leakage current measurement.

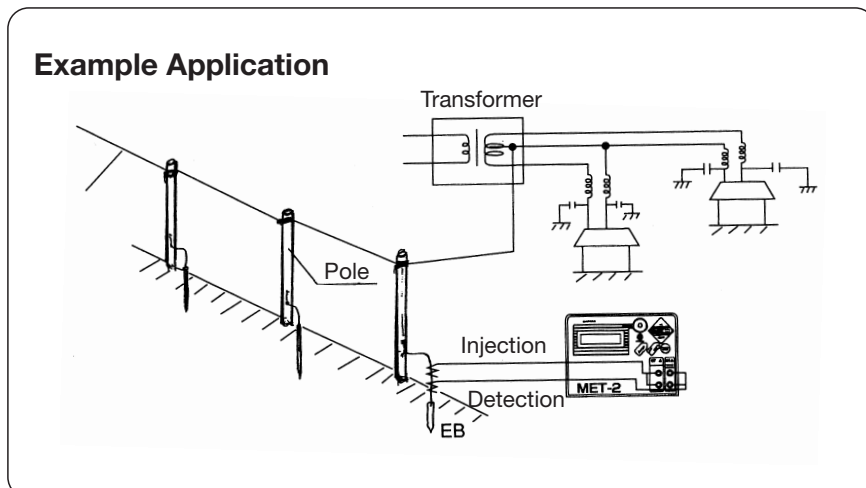

CLAMP EARTH TESTER

Model **MET-2**

SPECIFICATIONS

Measuring function	: Earth Resistance, AC Current (Line & Leakage)
Measuring method	: Dual integration mode
Display	: LCD 16 letters/characters × 2 line with contrast adjuster
Safety standard	: Meets the requirements for double insulation to IEC 61010-1 installation Category II. 600V phase to earth.
Sampling	: Approx. 2 times/second for AC current
Measuring time	: Approx. 30 second for earth resistance
Over range indication	: "OVER" on LCD readout both for AC current and earth resistance
Low battery indication	: "B" mark on LCD readout
Auto power off	: The meter is set to power off mode, approx. 5 minutes after the power switch on.
Data hold function	: "DH" mark on LCD readout
Memory function	: 40 measuring data can be stored and displayed
Accuracy	: 23°C ± 5°C, 80% RH max.

Earth Resistance

Range	Resolution	Accuracy
10 Ω	0.01 Ω	0.1 ~ 1 Ω : ± 0.1 Ω 1 ~ 10 Ω : ± 0.5 Ω
300 Ω	0.1 Ω	10 ~ 50 Ω : ± 2.0 Ω 50 ~ 150 Ω : ± 5.0 Ω 150 ~ 200 Ω : ± 20 Ω 200 ~ 300 Ω : ± 30 Ω

AC Current

Range	Resolution	Accuracy
200mA	0.1mA	3%rdg ± 8dgt
2000mA	1mA	2%rdg ± 8dgt
20A	0.01mA	2%rdg ± 8dgt

CT for detection	: 34 φ mm with 2.5m lead
CT for injection	: 34 φ mm, auto sweep 4KHz ~ 200KHz sine wave Signal injection level/approx. 320mV p-p
Storage temperature	: -10°C ~ 60°C, <80% without condensation
Operating temperature	: 0°C ~ 40°C, <80%RH without condensation
Limitation of Circuit voltage	: less than 500V low voltage circuit
Withstanding voltage	: AC 3700V, [1 minute between CT body and CT core.] AC 2300V, [1 minute between power supply and outer case.]
Insulation resistance	: More than 100MΩ [between CT body and CT core.] More than 50MΩ [between power supply and outer case.]
Power supply	: Internal Ni-Cad battery (1.2V × 5), Charger: AC200V/DC10V, 400mA
Power consumption	: Approx. 380mA [At earth resistance measurement]
Battery life	: 400 times measurement under full charged condition (Subject to the times of charging & discharging)
Size & weight	
CT for detection	: 90.5(W) × 165(H) × 38(D)mm, approx. 460grs
CT for injection	: 90.5(W) × 165(H) × 38(D)mm, approx. 440grs
Main body	: 190(W) × 140(H) × 42 (D)mm, approx. 800grs
Standard accessories	: One each of Detection CT Injection CT, Charger Carrying Case Instruction Manual & Subsidiary lead wire

VOLTAGE DETECTOR

AC Low Voltage

Model LV-1

WITH UNIQUE FUNCTION ENABLES TO JUDGE WHETHER THE INDICATION CAUSED FROM INDUCTION VOLTAGE OR INSULATION DEFECT.

THE ORDINARY VOLTAGE DETECTORS CANNOT DISCRIMINATE THE DANGER FROM ISOLATION DEFECT BUT THIS NEW MODEL LV-1 PROVIDES MORE SAFETY MEASUREMENT BY THE ABOVE FUNCTION.



FEATURES

- New Function to avoid Electric Shock.
- Using Conductive Rubber for Detector Tip free from short circuit.
- With Slip Stopper for the safety.

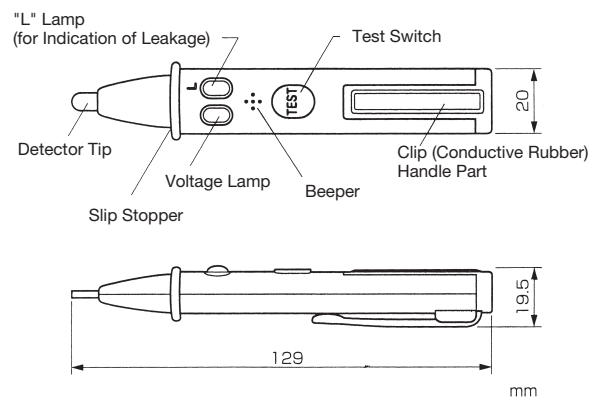

SPECIFICATIONS

Model	LV-1 (for AC low voltage only)
Voltage range	On the cover of wire AC50 ~ 500V (50/60Hz common use) On the Bare terminal AC0 ~ 300V (50/60Hz common use)
Isolation resistance	Over 10M Ω by DC500V Insulation Tester (between detecting tip and clip)
Isolation withstanding	One minute by AC1500V Insulation Tester (between detecting tip and clip)
Minimum responsible voltage to ground	Sensitivity adjustable. (initial adjustment for standard /AC40V with detecting tip in contact with insulated wire 1V 2mm)
Value for judgement of isolation defect	More than 10uA, floating to the human body ("L" lamp will turn on a light)
Display of indication	Visual : intermittent flashing red light for the both of voltage detect & isolation defect. Audio : intermittent beeper sound
Battery	Alkaline button cell : LR-44 \times 2 Pcs.
Operating temperature	0 $^{\circ}$ C ~ 40 $^{\circ}$ C
Size & weight	20(W) \times 129(H) \times 19.5(D) mm approx. 30gs
Accessories	Batteries(LR-44) 2 Pcs. Alligator clip for the earth 1 Pce. Instruction manual 1 Pce.

VOLTAGE DETECTOR

For AC and AC/DC Low Voltage

Model V-550



- LCD display of voltage with voltage detective function (beeper sound).
- Can measure voltage from the cover of conductor (estimated value).
- Accurate & safety measurement on the bare terminal, etc. free from short circuit.

SPECIFICATIONS

Max. measuring voltage	: AC500V
Auto power off	: 5 minutes after switch on
Date hold	: "DH" mark on LCD readout
Low battery indication	: "B" mark on LCD
Power supply	: 1.55V (LR-44) × 2
Power Consumption	: Continuous approx. 60 hours
Size	: 130(L) × 30(W) × 14(D) mm, approx. 37g
Accessories	: Battery 2 Soft case 1 Instruction Manual 1

Accuracy : 23 °C ± 5 °C, 80% RH or less

Range H	Range L
Bare terminal, Outlet bare conductor, etc.	on the insulated vinyl, rubber cover of conductor
Accuracy : ± 3% rdg	estimated value (according to materials, condition of wires, etc)

Display of voltage detection : 3 1/2 digit on LCD and beeper sound over 15V. Measuring circuit voltage : less than AC600V (50/60Hz)

Model VD-320



FEATURES

- Can measure AC/DC voltage of the bare terminal easily by one-hand operation and can judge the polarity of DC voltage.
- Can measure voltage even from the cover of conductor by touching the tip for 30 second. (Estimated value).
- Using conductive rubber tip, free from short circuit.
- Can measure DC voltage from 1.5V to 400V as well as AC voltage up to 500V.
- No effect on the measurement due to insulation ground condition, etc.

SPECIFICATIONS

Measurement circuit voltage	: less than 600V
Data hold	: "DH" mark on LCD readout
Low battery indication	: "B" mark on LCD readout
Power supply	: 1.55V (LR-44) × 2
Power consumption	: Continuous approx. 60 hours
Size	: 153(L) × 34(W) × 24(D) mm, approx. 60g
Accessories	: Battery 2, Soft case 1, Instruction manual 1

Accuracy : 23 °C ± 5 °C, 80% RH or less

	DC Voltage	AC Voltage
Range	400V/200V manual	500V (50/60Hz)
Polarity	"+" or "-" indication	Earth side/no indication Hot side/voltage value
Accuracy	± 5% rdg	± 5% rdg

POWER RECORDER

Model MPR-600S

FEATURES

- Low cost and high performance
- Can measure voltage, current, active power, apparent power, power factor, frequency, power integral(KWh) and integrated time.
- Data conformable to computer (time serial chart & load curve graph)
- Unique non-contact type voltage sensor (option)

FULLY EQUIPPED

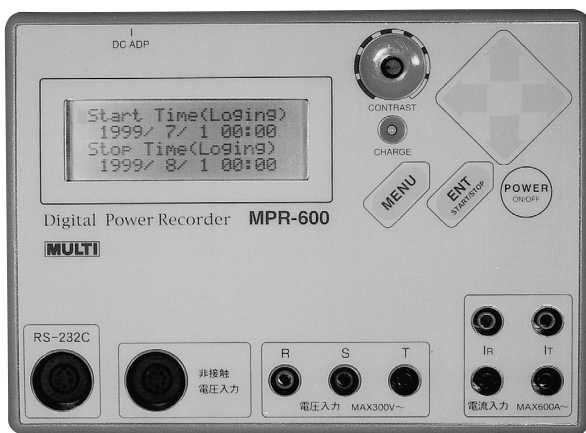

Main Instrument



Current Sensor
CT-40(600A max)



AC Adaptor



Voltage Input Sensor



RS-232C Cable



Software



Hard Carrying Case

OPTION



Model PS-60
Non-contact Type
Voltage Sensor



Model CT-80
Big Window
Current Sensor
80 ϕ mm
1000A max

POWER RECORDER

Model MPR-600S

SPECIFICATIONS

- Measurement Line : Single-phase/two-wires, Single-phase/three-wires, Three-phase/three-wires
- Measurement Items : Voltage, Current, Active Power, Apparent Power, Power Factor, Frequency, Power integral(KWh).
- Measuring Method : Voltage : Standard Clip Sensor for direct source or Optional Sensor PS-60 (non-touch source).
Current : CT Clamp sensor
Standard/CT-40 ϕ 40mm max. 600A
Option/CT-80P ϕ 80mm max.1000A
- Measurement Range : Voltage : 0 ~ 500V
Current : 10/50/100/600A
Active Power : depends on combination of V & A range
Power Factor : 0 ~ 100%
Frequency : 45 ~ 65Hz
- Basic Accuracy : Voltage : $\pm 0.5\%$ rdg $\pm 0.3\%$ FS
Current : ± 0.5 rdg $\pm 0.3\%$ FS + Clamp accuracy
Active Power : $\pm 0.5\%$ rdg $\pm 0.5\%$ FS + Clamp accuracy
Power Factor : $\pm 0.2\%$ rdg + Clamp accuracy to T.Rms
- Measurement Interval : 1/5/10/15/30/60 minutes
- Memory Factor : Measuring Time, Conditions and Average Voltage/Current/Active Power/Power integral/Power Factor of measuring interval.
- Memory Capacity : approx. 210 days with 30min. interval.
- Memory output : RS-232C (standard accessories including cord & software).
- Other Functions : Measurement Start/End setting, Clock display, Battery Power Warning display, PT/CT ratio setting
- Power Supply : AC100V with adaptor (for domestic).
Internal Ni-hydride battery.
- Measurement Temp. & Hum. : 0°C ~ 50°C / under 80% RH (without condensing).
- Storage Temp. & Hum. : -10°C ~ 60°C / under 80% RH (without condensing).
- Dimensions & Weight : 190(W) \times 140(H) \times 42(D)mm, approx. 800gs
- Standard Accessories : Voltage Clip Sensor (Red, Black, White) /1 set
Clamp-on CT ϕ 40mm /2 pcs.
RS-232C Cable /1 pce.
Software/ 1 set. (Japanese version only for the time being)
AC adaptor/ 1 pce.
Instruction Manual/ 1 pce. Hard Carrying Case/ 1 pce.
- Optional Accessories : PS-60 Voltage Sensor
CT-80P Current Sensor

EXAMPLE DATA DISPLAY ON THE COMPUTER

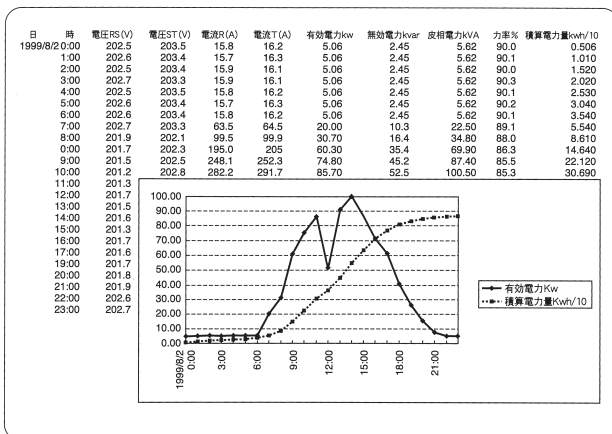

DIMENSION OF MAIN INSTRUMENT

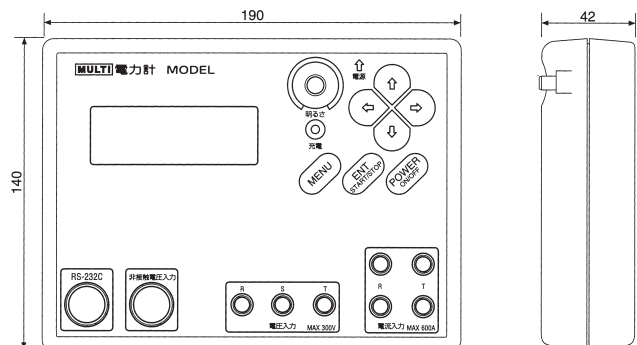

HI-FREQUENCY AC/DC CURRENT PROBE**Model LAD-20****SPECIFICATIONS**

Measuring method	: Clamp CT
Current detection method	: Closed loop system
Measuring range	: AC 0~20A(RMS), DC 0~±30A
Output voltage	: 100mV/A
Accuracy (at 23°C±5°C)	: ±1%rdg±5mA (DC~100Hz)
Frequency characteristic	: -1.5dB (DC~100KHz)
Load impedance	: less than 100pF at more than 10KΩ
Influence of conductor position	: less than ±1%
DC 0 adjustment for output	: by manual knob
Max. applicable conductor	: Φ17mm
Power Supply	: ① 9V alkaline battery (6LR61) ② AC adapter
Current consumption	: Approx. 20mA at the time of 0 input
Cable length	: 2m
Circuit voltage	: less than AC/DC 300V
Operating temperature	: 0~50°C, 15~85%RH w/o condensation
Storage temperature	: -20~85°C, less than 80%RH w/o condensation
Withstanding voltage	: AC 3700V/1 minute (without use of AC adapter)
Conformity of standard	: CE CAT II 300V, RoHS

Io Ior MINI DIGITAL LEAKAGE CLAMP TESTER

Model 340IR



FEATURES

- Detection for resistive leakage current (Ior)
- Compact size and light weight
- Conform to IEC safety requirements (IEC1010-1, CAT II 600V)

2CT METHOD MINI DIGITAL CLAMP TESTER**Model 2002****FEATURES**

- Leakage current detection by 2CT method
- 40mm ϕ CT window and compact size
- Wide ranges from mA up to 200A and true-rms reading
- Conform to IEC safety requirements (CAT II 600V)

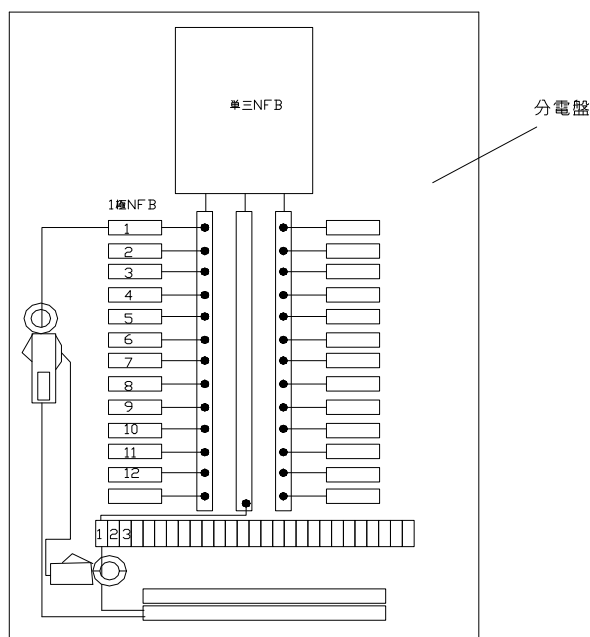

Model 2002 can measure load and leakage current by general method in the same manner as ordinary clamp meters but also can detect leakage current by using 2CT method in combination with optional CT sensor even in the fields where CT cannot be clamped to two wires in the single phase system.

SPECIFICATIONS

1. CURRENT DETECTION PART (Instrument CT)

Inside diameter : ϕ 40mm
 Withstanding voltage : AC 2000V/1 minute between CT core and grip

2. MEASURING PART

Measuring function : Line Current, Leakage Current, 2CT Leakage Current
 Measuring method : Clamp CT
 Measuring range : Leakage Current 0~200mA/2000mA (50/60 Hz)
 Line Current 0~20A/200A (50/60 Hz)
 Range selection : 4 range manual
 AC current detection : True RMS
 A/D conversion : Equivalent dual integration mode
 Sampling rate : 2 times/sec.
 Display : Max. 1999 reading with annunciators
 Over range indication : "OL" mark on LCD
 Data hold indication : "DH" mark on LCD
 Low battery indication : "B" mark on LCD

3. GENERAL SPECIFICATION

Circuit voltage : less than AC 600V
 Operating temperature : 0~40°C, < 85%RH without condensation
 Storage temperature : -10~60°C, < 80%RH without condensation
 Withstanding voltage : AC 2000V/1 minute between CT core and grip
 Power supply : LR03 \times 3 pcs.
 Dimension : 64(W) \times 1950(H) \times 24(D)mm
 Standard accessories : LR03 battery \cdots 3 (installed in the body case),
 Instruction manual \cdots 1, Soft Case \cdots 1,
 Spare CT (CTP-05-2) \cdots 1
 Option : Spare CT ZCT-18-2



Spare CT CT-05-2
 Inside diameter : ϕ 5mm
 Dimension : 25(W) \times 113(H) \times 19(D)



Spare CT ZCT-18-2 (Option)
 Inside diameter : ϕ 18mm
 Dimension : 45(W) \times 140(H) \times 20(D)

4. ACCURACY (23°C \pm 5°C, less than 85%RH)

Range	Resolution	Accuracy
AC 200mA	0.1mA	$\pm 1.0\%rdg \pm 5dgt$
AC 2A	0.001A	
AC 20A	0.01A	
AC 200A	0.1A	

SPECIFICATIONS

1. CURRENT DETECTION ZCT

Inside diameter : 40mm
 Method : Split core type ZCT
 Secondary windings : 2000 turns
 Withstanding voltage : AC 2200V/1 minute between CT core and grip

2. MEASURING PART

Measuring function : Leakage current (I_o), Line current, Resistive leakage current (I_{or})
 Measuring Method : Clamp CT (in case of I_{or}, based on voltage standard)
 Measuring range : I_o 0-10mA/100mA/1000mA, I_{or} 0-10mA/100mA
 Input frequency range : 45-65Hz (with switch for 50/60Hz)
 AC current detection : Dual integration mode
 AD conversion : Successive approximation method
 Display : LCD, max.9999 reading with annunciator
 Data hold indication : "DH" mark on LCD
 Sampling rate : 2 times/sec.
 Low battery indication : "B" mark on LCD
 Circuit voltage : less than AC 600V
 Operating temperature : 0 ~ 50 °C, < 80%RH (without condensation)
 Storage temperature : -10 ~ 60 °C, < 70%RH (without condensation)
 Auto power off : Approx. 10 minutes after power on
 Power supply : LR03 × 3
 Dimension : 44(W) × 197(H) × 24(D)mm
 Accessories : Soft Case, Test Lead, Batteries, Instruction Manual

Accuracy (23 °C ± 5 °C, less than 80%RH)

	Range	Resolution	Accuracy
I _{or}	10mA	0.001mA	± 1.5%rdg ± 10dgt
	100mA	0.01mA	± 1.2%rdg ± 10dgt
I _o	10mA	0.001mA	± 1.0%rdg ± 10dgt
	100mA	0.01mA	± 1.0%rdg ± 10dgt
	1000mA	0.1mA	± 1.0%rdg ± 10dgt

Distributed by

MULTI MEASURING INSTRUMENTS CO., LTD.

Santomo Bldg., Kanda Matunagicho 15

Chiyoda-ku, Tokyo Japan

Tel : 81-3-3251-7013 Fax : 81-3-3253-4278

Home Page : <http://www.multimic.com/>

E-mail : multi@multmic.com

● For Additional Information Write or Phone